

NOTES:

1. APPLICABLE STANDARDS/SPECIFICATIONS:
A: DOD-STD-100G
B: ASME Y14.5M-1994
2. ASTM E380 APPLIES. METHOD B SHALL BE USED IN CONVERTING AND ROUNDING OFF.
1 INCH=25.4mm APPLIES.

- 3 B4 HEATER POSITIONS
0 - OFF
1 - LOW
2 - MED
3 - HIGH

CIRCUIT BREAKER	BATTERY	FUSE	OPEN CONTACT	CLOSED CONTACT	SWITCH	PUSHBUTTON	FILTER
SPLICE	ALTERNATOR	MOTOR	CONNECTOR	TERMINAL BLOCK	PRESSURE SWITCH	TEMPERATURE SWITCH	AUDIBLE ALARM
PDP LED	LAMP	LED	DUAL BEAM LAMP	BLACKOUT MARKER	METER OR GAUGE	POWER OR GROUND	DIODE
RESISTOR	SENSOR	RECEPTACLE	CONNECTION	RELAY	SOLENOID	GROUND	

REVISIONS			
ZONE	REV	DESCRIPTION	DATE
		INITIAL RELEASE -PRODUCT BASELINE- ERR SSS-U5777	
A	1-3	SEE SHEET 3	
	4-6	SEE SHEET 7	
		ERR SSS-U5778	02-02-27
B	1-6	SEE SHEET 2	
	7	SEE SHEET 3	
	9-13	SEE SHEET 6	
		ERR SSS-U5788	02-03-06
A2	C	REVISED IAW R2 CHANGES 1) J. QUADERER WAS M. TOWNSEND (2 PLCS) 2-3) SEE SHEET 2 4-5) SEE SHEET 3 6) SEE SHEET 4 7) SEE SHEET 5 8-9) SEE SHEET 6 10-11) SEE SHEET 7 12-13) SEE SHEET 8 14-15) SEE SHEET 9 16) SEE SHEET 10 17) SEE SHEET 11 18) SEE SHEET 12 19) SEE SHEET 13 20) SEE SHEET 14 21) SEE SHEET 15 22) SEE SHEET 16 23) SEE SHEET 17 24) SEE SHEET 18 25) SEE SHEET 19 26) SEE SHEET 20	
		ERR SSS-U5806	02-07-11
D	1)	DISTRIBUTION STATEMENT C: WAS A	
	2-4)	SEE SHEET 2	
	5-16)	SEE SHEET 3	
	17)	SEE SHEET 4	
	18)	SEE SHEET 5	
	19)	SEE SHEET 6	
	20)	SEE SHEET 7	
	21)	SEE SHEET 8	
	22-25)	SEE SHEET 9	
	26)	SEE SHEET 10	
	27)	SEE SHEET 11	
	28)	SEE SHEET 12	
	29)	SEE SHEET 13	
	30)	SEE SHEET 14	
	31-32)	SEE SHEET 15	
	33)	SEE SHEET 16	
	34)	SEE SHEET 17	
	35)	SEE SHEET 18	
	36)	SEE SHEET 19	
	37)	SEE SHEET 20	
		ERR SSS-U5882	02-09-18
E	1-3)	SEE SHEET 3	
		ERR SSS-U7377	02-12-12
F	1)	SEE SHEET 12	
		ERR SSS-U7390	03-02-12
G	1)	SEE SHEET 3	
	2)	SEE SHEET 6	
		ERR SSS-U7385	03-04-22

CM APPROVED
1-29-04
PERECP7385R1
DOCUMENT

D	D	D	D	D
SHEET 20	SHEET 19	SHEET 18	SHEET 17	SHEET 16
D	D	D	F	D
SHEET 15	SHEET 14	SHEET 13	SHEET 12	SHEET 11
D	D	D	D	G
SHEET 10	SHEET 9	SHEET 8	SHEET 7	SHEET 6
D	D	G	D	G
SHEET 5	SHEET 4	SHEET 3	SHEET 2	SHEET 1

REVISION STATUS OF SHEETS

DISTRIBUTION STATEMENT C:
DISTRIBUTION AUTHORIZED TO U.S. GOVERNMENT AGENCIES AND THEIR CONTRACTORS.
REASON: ADMINISTRATIVE OR OPERATIONAL USE.
DATE OF DETERMINATION: 02-09-18
OTHER REQUESTS FOR THIS DOCUMENT SHALL BE REFERRED TO THE U.S. ARMY TANK AUTOMOTIVE AND ARMAMENTS COMMAND, ATTN: SFAE-CSS-MT. WARREN, MICHIGAN 48397-5000

DESTRUCTION NOTICE: FOR UNCLASSIFIED, LIMITED DOCUMENTS DESTROY BY ANY METHOD THAT WILL PREVENT DISCLOSURE OF CONTENTS OR RECONSTRUCTION OF THE DOCUMENT.

MECHANICAL PROPERTIES	PMIC A	UNLESS OTHERWISE SPECIFIED DIMENSIONS ARE IN MILLIMETERS TOLERANCES ON 1 PLACE ± 2 PLACE ±	CONTRACT NUMBER DAAE07-99-C-3030	DESIGN ACTIVITY U.S. ARMY, TANK AUTOMOTIVE COMMAND WARREN, MICHIGAN 48397-5000
YP			CONTRACTOR STEWART & STEVENSON SERVICES SEALY, TEXAS U.S.A.	SCHEMATIC, ELECTRICAL
TS			DATE (YY-MM-DD) 02-02-27	SIZE E 19207
EL2			CHECKER S.E.HALL	CAGE CODE 12422872
RA			ENGINEER L.RODNEY	DWG NO 12422872
BH	12422870		DESIGN APPROVAL - GOV'T J.QUADERER	SCALE NONE
RH	12422869	FMTV A1	MAT'L ENGR M.CHURCH	UNIT WT
	NEXT ASSY USED ON APPLICATION		DESIGN APPROVAL - GOV'T J.QUADERER	SHEET 1 OF 20

FILE NAME 1755GE1.DWG TACOM-E-METRIC

Table with columns: EQUIPMENT LIST REF, REFERENCE DESIGNATION, DESCRIPTION, SHEET NUMBER, LOCATION. Includes multiple sheets (A-H) and a detailed parts list.

REVISIONS table with columns: ZONE, REV, DESCRIPTION, DATE, APPROVED. Lists changes to the drawing.

CM APPROVED
1-29-04
PERECP7385R1
DOCUMENT

EQUIPMENT LIST REF table with columns: REFERENCE DESIGNATION, DESCRIPTION, SHEET NUMBER, LOCATION. Lists specific components and their locations.

DISTRIBUTION STATEMENT C: DISTRIBUTION AUTHORIZED TO U.S. GOVERNMENT AGENCIES AND THEIR CONTRACTORS. REASON: ADMINISTRATIVE OR OPERATIONAL USE...

DESTRUCTION NOTICE: FOR UNCLASSIFIED, LIMITED DOCUMENTS DESTROY BY ANY METHOD THAT WILL PREVENT DISCLOSURE OF CONTENTS OR RECONSTRUCTION OF THE DOCUMENT.

MECHANICAL PROPERTIES, TOLERANCES ON, THIRD ANGLE PROJECTION, CONTRACT NUMBER (DAAE07-99-C-8030), DRAWN BY (A.JOINER), CHECKED BY (S.E.HALL), DATE (02-02-27), SCALE (NONE), SHEET (2).

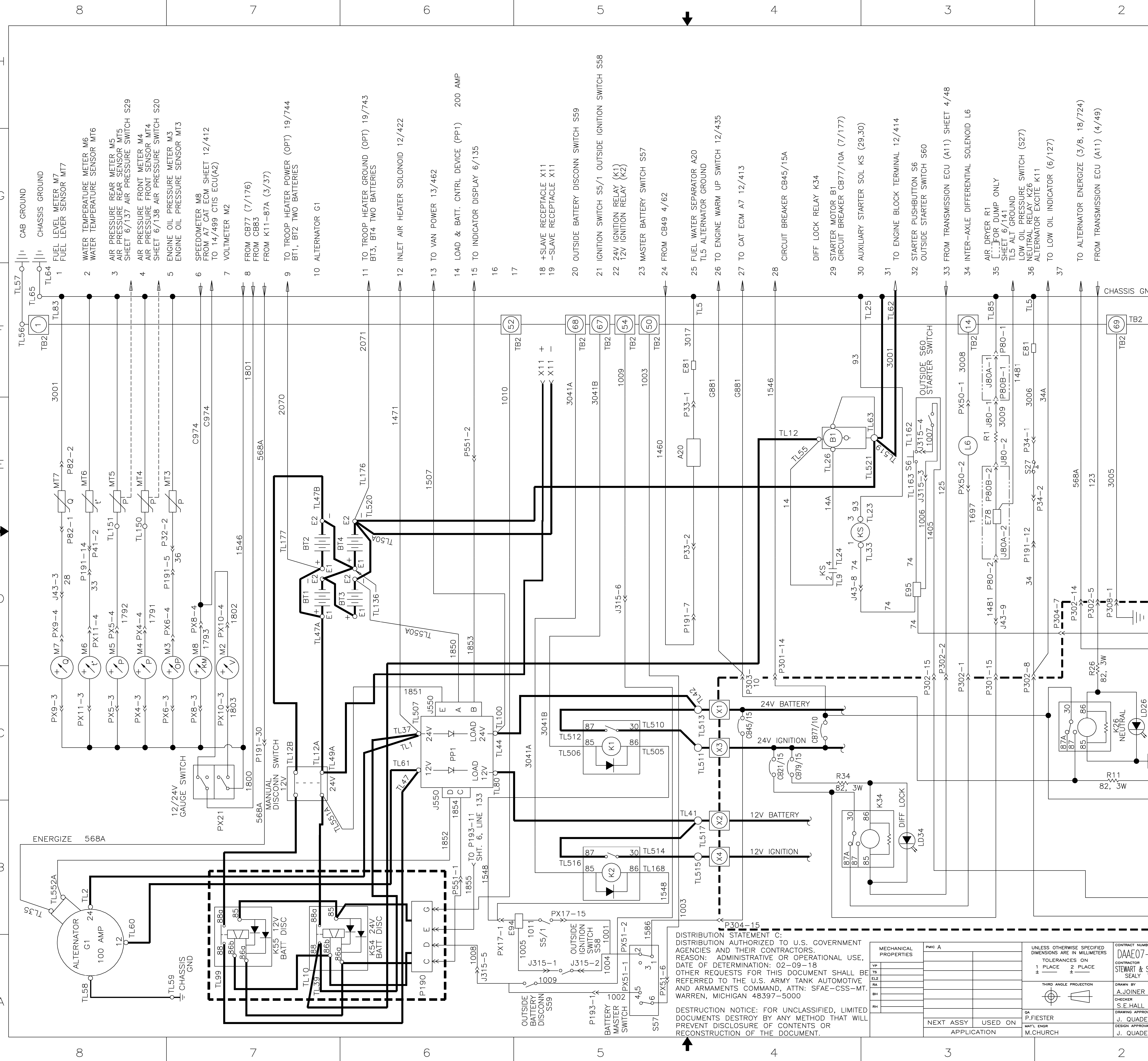

ZONE/REV	DESCRIPTION	DATE	APPROVED
1	ALL REVISIONS LISTED ON SH. 1		
2	INITIAL RELEASE - PRODUCT BASELINE - ERR SSS-5777		
3	ADDED GAUGE SWITCH AND ROUTING (2 PLCS)		
4	WIRE # 1802 WAS 3004		
5	ADDED TEXT "FROM CB83" AND ROUTING		
6	REVISD DWG TO SHOW ROUTING TO INDICATOR DISPLAY, LOAD & BATT CNTRL DEVICE, (PP1) & J550	02-02-27	L.RODNEY
7	REVISED IAW R1 CHANGES	02-03-06	D.FRISS
8	REVISED DWG		
9	REVISED IAW R2 CHANGES		
10	J. QUADERER WAS M. TOWNSEND (2 PLCS)	02-07-11	L.RODNEY
11	ERR SSS-5806		
12	MOVED K54 & K55		
13	MOVED ALTERNATOR		
14	P190 WAS P193 AND REDRWAN WITH ROUTING		
15	MOVED 12V AND 24V MANUAL DISCONN SW		
16	J315-3 WAS J315-5&6 AND ADDED GEOM		
17	ADDED WIRE # 1009 AND 1003		
18	ADDED PX51 & GEOM		
19	ADDED J315-6 & GEOM		
20	ADDED GEOM FOR J315-3 & 4		
21	ADDED P109-1 AND GEOM		
22	ADDED GEOM FOR J315-1&2		
23	DISTRIBUTION STATEMENT C: WAS A		
24	ERR SSS-5882	02-09-19	L.RODNEY
25	MOVED TL550A FROM E1 TO E2 ON BT3		
26	CORRECTED POSITION ON MANUAL DISCONN SWITCH	02-12-12	L.RODNEY
27	CORRECTED POSITION ON BATTERY MASTER SWITCH		
28	ERR SSS-57377		
29	MOVED TL551A FROM E1 ON BT1 TO 12V DISCONN SWITCH		
30	ERR SSS-57385	03-04-22	R.VIGIL

CM APPROVED
1-29-04
PERECP7385R1
DOCUMENT

POWER DISTRIBUTION PANEL (PDP)

DISTRIBUTION STATEMENT C:
DISTRIBUTION AUTHORIZED TO U.S. GOVERNMENT AGENCIES AND THEIR CONTRACTORS.
REASON: ADMINISTRATIVE OR OPERATIONAL USE.
DATE OF DETERMINATION: 02-09-18
OTHER REQUESTS FOR THIS DOCUMENT SHALL BE REFERRED TO THE U.S. ARMY TANK AUTOMOTIVE AND ARMAMENTS COMMAND, ATTN: SFAE-CSS-MT, WARREN, MICHIGAN 48397-5000

DESTRUCTION NOTICE: FOR UNCLASSIFIED, LIMITED DOCUMENTS DESTROY BY ANY METHOD THAT WILL PREVENT DISCLOSURE OF CONTENTS OR RECONSTRUCTION OF THE DOCUMENT.

MECHANICAL PROPERTIES	PMIC A	UNLESS OTHERWISE SPECIFIED DIMENSIONS ARE IN MILLIMETERS	CONTRACT NUMBER DAAE07-99-C-3030	DESIGN ACTIVITY U.S. ARMY, TANK AUTOMOTIVE COMMAND WARREN, MICHIGAN 48397-5000
		TOLERANCES ON 1 PLACE 2 PLACE ± 0.15 ± 0.25	CONTRACTOR STEWART & STEVENSON SERVICES SEALY, TEXAS U.S.A.	
		THIRD ANGLE PROJECTION	DRAWN BY A.JOINER	DATE (YY-MM-DD) 02-02-27
			CHECKER S.E.HALL	ENGINEER L.RODNEY
			DRAWING APPROVAL - GOV'T J. QUADERER	
			MAT'L ENGR M.CHURCH	
NEXT ASSY APPLICATION	USED ON	SCALE NONE	SIZE E	CAGE CODE 19207
		UNIT WT	DWG NO 12422872	SHEET 3
			FILE NAME 2872DEX.DWG	TACOM-E-METRIC

REVISIONS			
ZONE/REV	DESCRIPTION	DATE	APPROVED
---	ALL REVISIONS LISTED ON SH. 1	---	---
---	INITIAL RELEASE -PRODUCT BASELINE- ERR SSS-U5777	---	---
A2	C REVISED IAW R2 CHANGES 6) J. QUADERER WAS M. TOWNSEND (2 PLCS) ERR SSS-U5806	02-07-11	L.RODNEY LJR/SEH
A4	D 17) DISTRIBUTION STATEMENT C: WAS A: ERR SSS-U5882	02-09-18	L.RODNEY ADJ/SEH

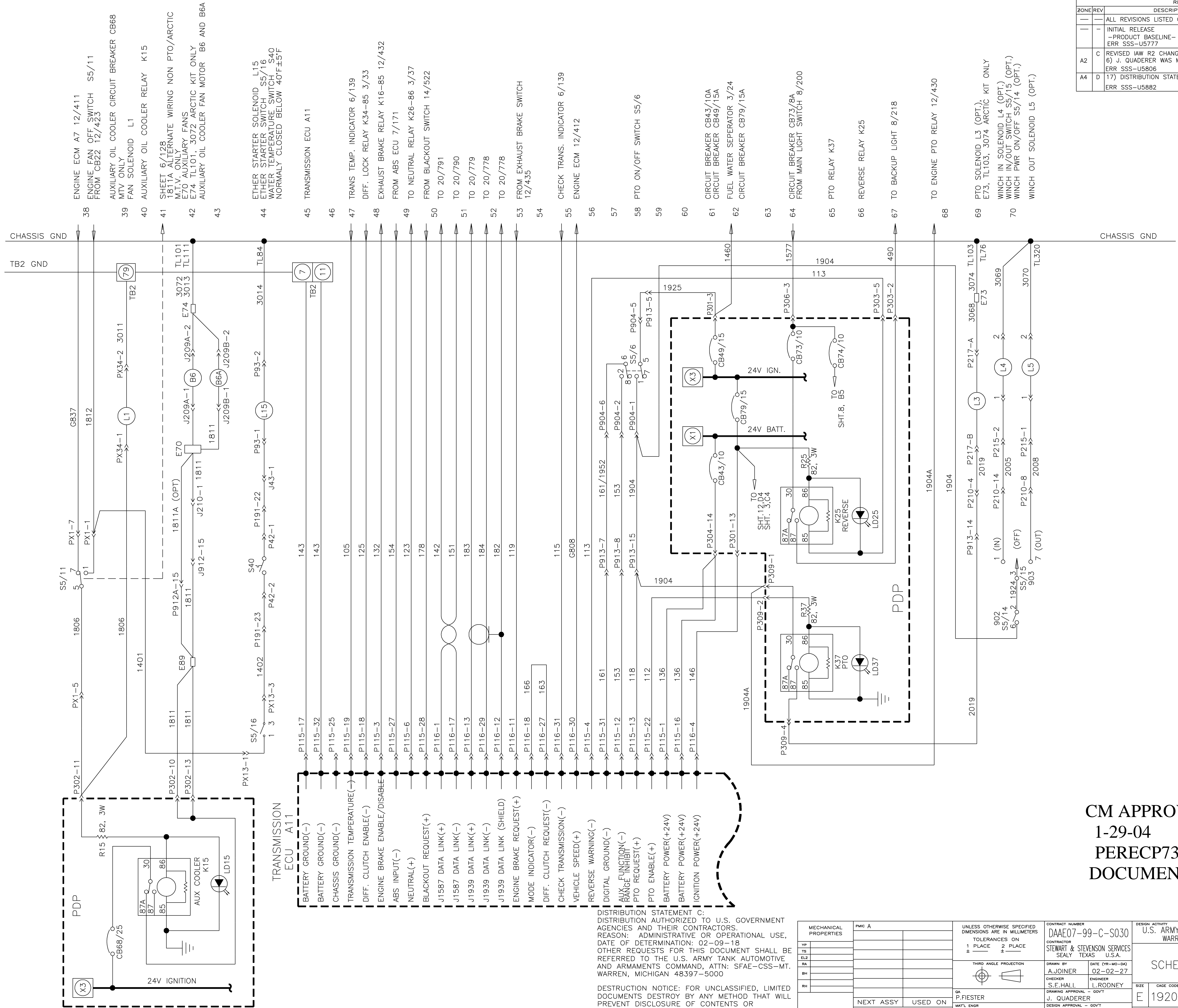

ENGINE ECM A7 12/411
ENGINE FAN OFF SWITCH S5/11
FROM CB22 12/423
AUXILIARY OIL COOLER CIRCUIT BREAKER CB68
MTV ONLY
FAN SOLENOID L1
AUXILIARY OIL COOLER RELAY K15

SHEET 6/128
ALTERNATE WIRING NON PTO/ARCTIC
MTV ONLY
E70 AUXILIARY FANS
E74 TL101, 3072 ARCTIC KIT ONLY
AUXILIARY OIL COOLER FAN MOTOR B6 AND B6A

ETHER STARTER SOLENOID L15
ETHER STARTER SWITCH S5/16
WATER TEMPERATURE SWITCH S40
NORMALLY CLOSED BELOW 40°F±5°F

TRANSMISSION ECU A11

TRANS TEMP. INDICATOR 6/139
DIFF. LOCK RELAY K34-85 3/33
EXHAUST BRAKE RELAY K16-85 12/432
FROM ABS ECU 7/171
TO NEUTRAL RELAY K26-86 3/37
FROM BLACKOUT SWITCH 14/522
TO 20/791
TO 20/790
TO 20/779
TO 20/778
TO 20/778

FROM EXHAUST BRAKE SWITCH
12/435

CHECK TRANS. INDICATOR 6/139
ENGINE ECM 12/412

PTO ON/OFF SWITCH S5/6

CIRCUIT BREAKER CB43/10A
CIRCUIT BREAKER CB49/15A
FUEL WATER SEPARATOR 3/24
CIRCUIT BREAKER CB79/15A

CIRCUIT BREAKER CB73/8A
FROM MAIN LIGHT SWITCH 8/200

PTO RELAY K37
REVERSE RELAY K25
TO BACKUP LIGHT 8/218
TO ENGINE PTO RELAY 12/430

PTO SOLENOID L3 (OPT.)
E73, TL103, 3074 ARCTIC KIT ONLY
WINCH IN SOLENOID L4 (OPT.)
WINCH IN/OFF SWITCH S5/15 (OPT.)
WINCH PWR ON/OFF S5/14 (OPT.)
WINCH OUT SOLENOID L5 (OPT.)

DISTRIBUTION STATEMENT C:
DISTRIBUTION AUTHORIZED TO U.S. GOVERNMENT
AGENCIES AND THEIR CONTRACTORS.
REASON: ADMINISTRATIVE OR OPERATIONAL USE,
DATE OF DETERMINATION: 02-09-18
OTHER REQUESTS FOR THIS DOCUMENT SHALL BE
REFERRED TO THE U.S. ARMY TANK AUTOMOTIVE
AND ARMAMENTS COMMAND, ATTN: SFAE-CSS-MT.
WARREN, MICHIGAN 48397-5000

DESTRUCTION NOTICE: FOR UNCLASSIFIED, LIMITED
DOCUMENTS DESTROY BY ANY METHOD THAT WILL
PREVENT DISCLOSURE OF CONTENTS OR
RECONSTRUCTION OF THE DOCUMENT.

MECHANICAL PROPERTIES	PMIC A
YF	
YS	
EL	
BI	
RE	
HH	
NEXT ASSY USED ON APPLICATION	

UNLESS OTHERWISE SPECIFIED
DIMENSIONS ARE IN MILLIMETERS
TOLERANCES ON
1 PLACE 2 PLACE
± ±

THIRD ANGLE PROJECTION

QA
P.FIESTER
MTRL ENGR
M.CHURCH

CONTRACT NUMBER DAAE07-99-C-5030	DESIGN ACTIVITY U.S. ARMY, TANK AUTOMOTIVE COMMAND WARREN, MICHIGAN 48397-5000
CONTRACTOR STEWART & STEVENSON SERVICES SEALY TEXAS	SCHEMATIC, ELECTRICAL
DRAWN BY A.JOINER	DATE (YR-MO-DAY) 02-02-27
CHECKER S.E.HALL	ENGINEER L.RODNEY
DRAWING APPROVAL - GOV'T J. QUADERER	SCALE NONE
DESIGN APPROVAL - GOV'T J. QUADERER	CAGE CODE 19207
	UNIT WT
	DWG NO 12422872
	SHEET 4

CM APPROVED
1-29-04
PERECP7385R1
DOCUMENT

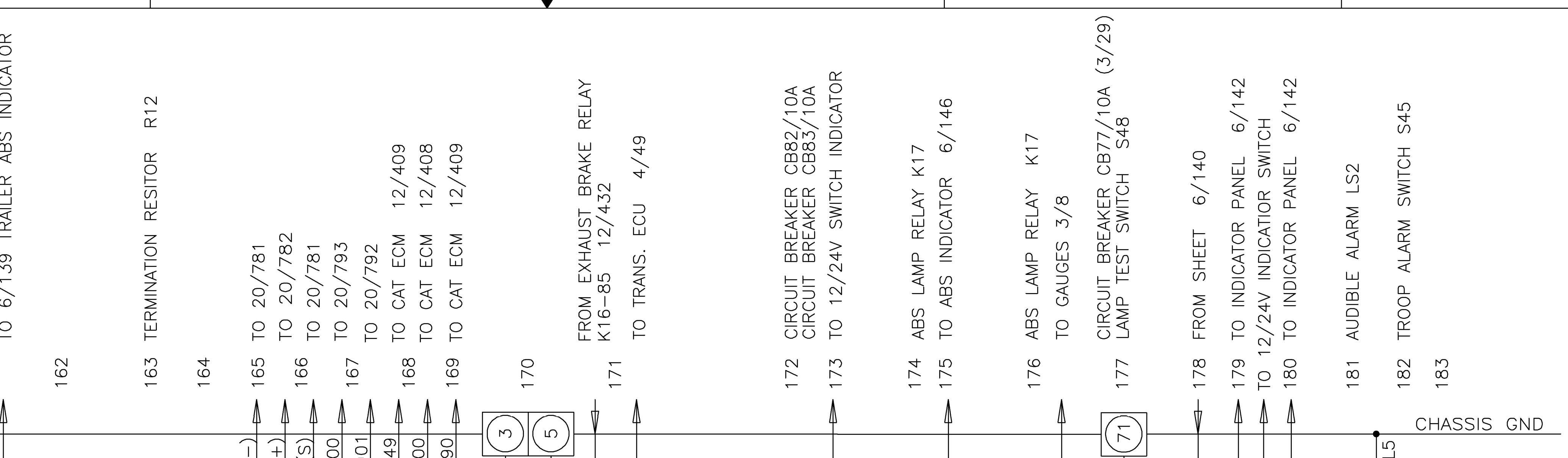
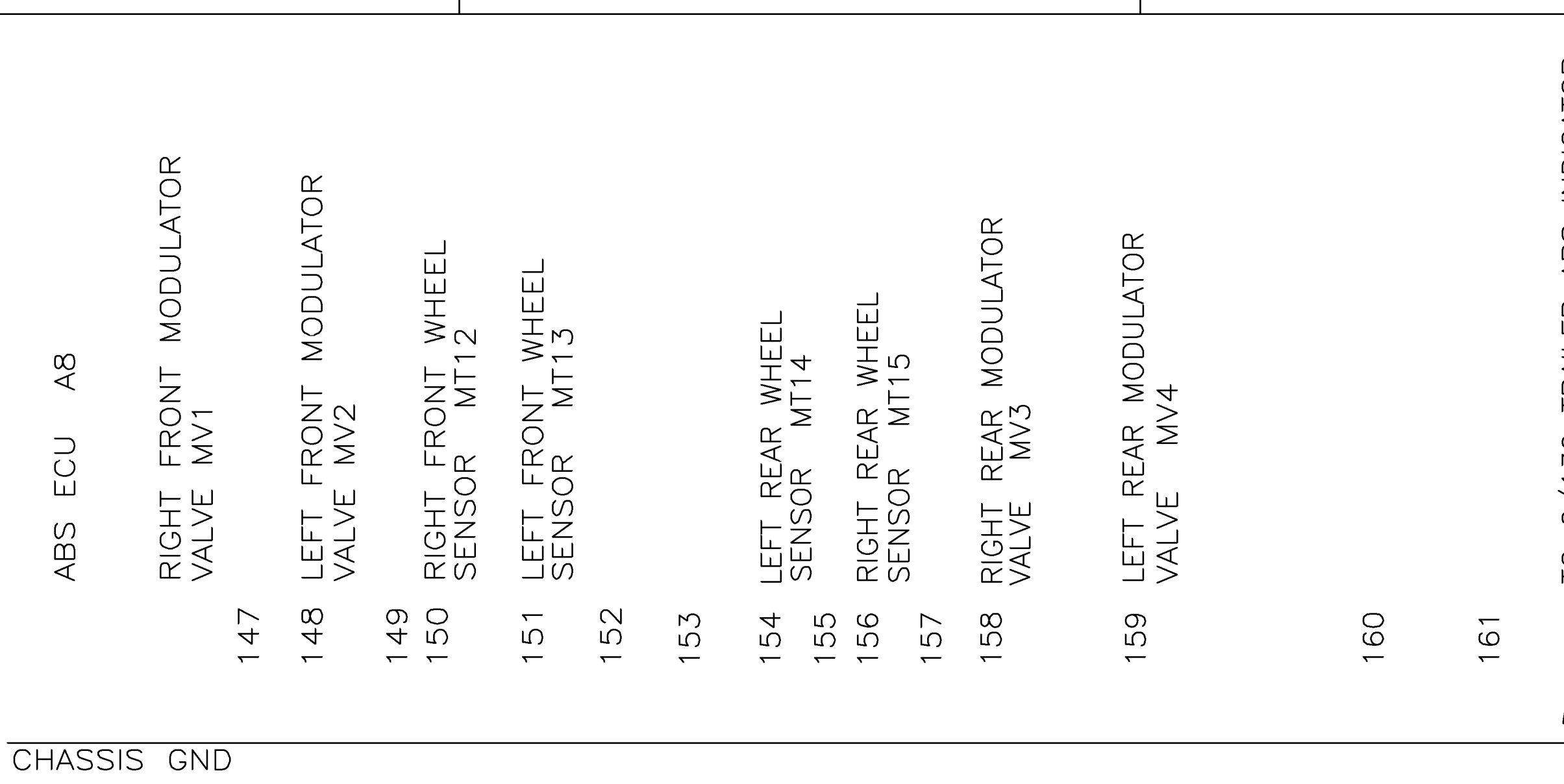
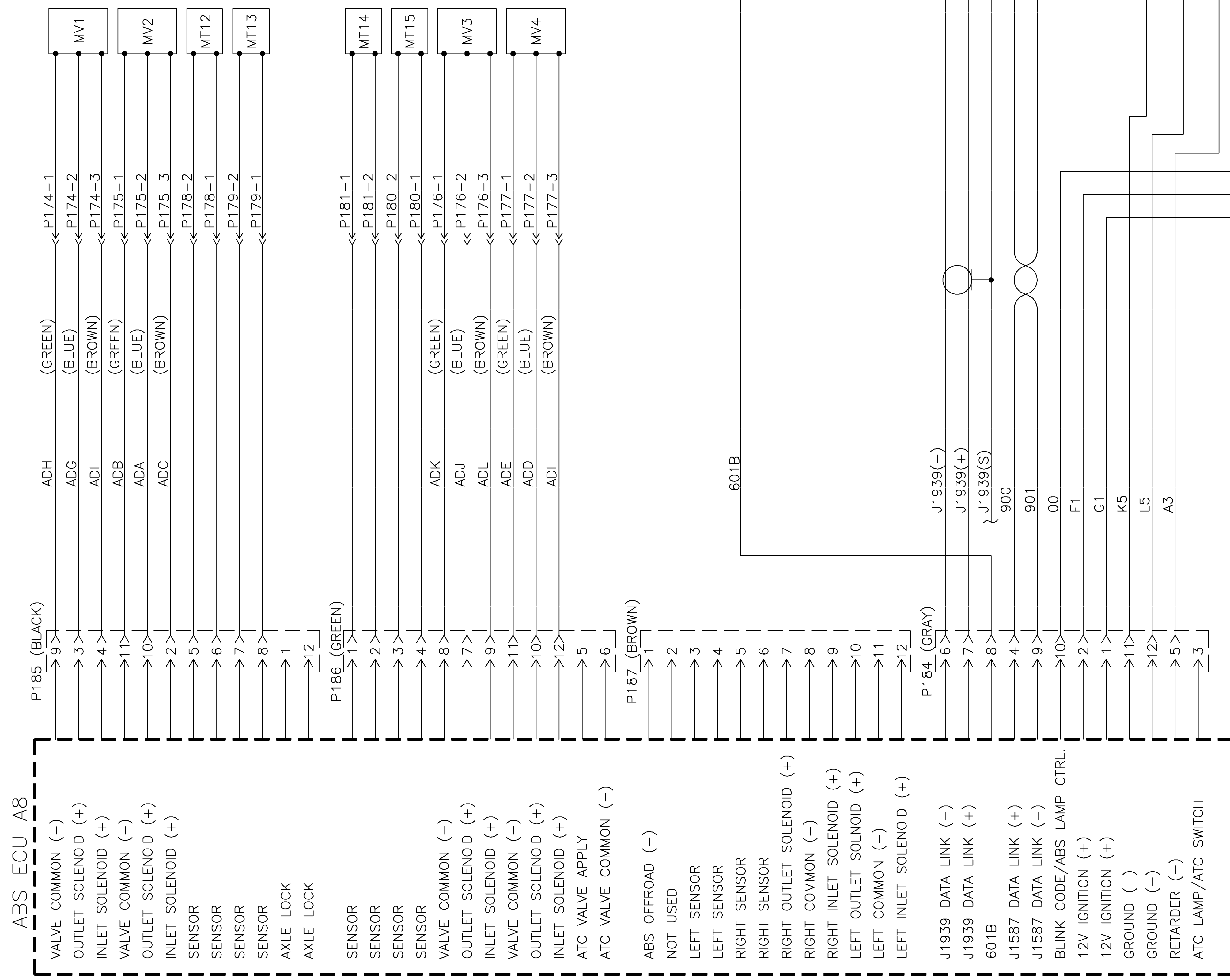

REVISIONS				
ZONE	REV	DESCRIPTION	DATE	APPROVED
		ALL REVISIONS LISTED ON SH. 1		
		INITIAL RELEASE		
		-PRODUCT BASELINE-		
		ERR SSS-U5777		
F4	A	4) ADDED WIRE# 1802 & ROUTING TO 173		
F3	G3	5) ADDED WIRE# 1800 & ROUTING		
		6) ADDED TEXT TO 12/24V SWITCH INDICATOR (2 PLCS)		
			02-02-27	L.RODNEY LUR/SEH
F4	C	10) WIRE# 1801 WAS 1802		
A2		REVISED IAW R2 CHANGES		
		11) J. QUADERER WAS M. TOWNSEND (2 PLCS)		
		ERR SSS-U5806	02-07-11	L.RODNEY LUR/SEH
A4	D	20) DISTRIBUTION STATEMENT C: WAS A:		
		ERR SSS-U5882	02-09-18	L.RODNEY ADJ/SEH

CM APPROVED
1-29-04
PERECP7385R1
DOCUMENT

DISTRIBUTION STATEMENT C:
DISTRIBUTION AUTHORIZED TO U.S. GOVERNMENT AGENCIES AND THEIR CONTRACTORS.
REASON: ADMINISTRATIVE OR OPERATIONAL USE, DATE OF DETERMINATION: 02-09-18
OTHER REQUESTS FOR THIS DOCUMENT SHALL BE REFERRED TO THE U.S. ARMY TANK AUTOMOTIVE AND ARMAMENTS COMMAND, ATTN: SFAE-CSS-MT. WARREN, MICHIGAN 48397-5000

DESTRUCTION NOTICE: FOR UNCLASSIFIED, LIMITED DOCUMENTS DESTROY BY ANY METHOD THAT WILL PREVENT DISCLOSURE OF CONTENTS OR RECONSTRUCTION OF THE DOCUMENT.

MECHANICAL PROPERTIES	PMIC A	UNLESS OTHERWISE SPECIFIED DIMENSIONS ARE IN MILLIMETERS TOLERANCES ON 1 PLACE 2 PLACE ± ±	CONTRACT NUMBER DAAE07-99-C-8030	DESIGN ACTIVITY U.S. ARMY, TANK AUTOMOTIVE COMMAND WARREN, MICHIGAN 48397-5000
	CONTRACTOR STEWART & STEVENSON SERVICES SEALY TEXAS U.S.A.		SCHEMATIC, ELECTRICAL	
YP		THIRD ANGLE PROJECTION	DRAWN BY A.JOINER	DATE (YY-MM-DA) 02-02-27
TS			CHECKER S.E.HALL	ENGINEER L.RODNEY
EL			DRAWING APPROVAL - GOV'T P.FIESTER	
RA			MAT'L ENGR J. QUADERER	DESIGN APPROVAL - GOV'T J. QUADERER
BH				
REVISIONS				
SIZE	E 19207	CAGE CODE	12422872	DWG NO
SCALE	NONE	UNIT WT		SHEET 7
FILE NAME	287207.DWG		TACOM-E-METRIC	

REVISIONS				
ZONE	REV	DESCRIPTION	DATE	APPROVED
—	—	ALL REVISIONS LISTED ON SH. 1	—	—
—	—	INITIAL RELEASE —PRODUCT BASELINE— ERR SSS-U5777	—	—
D6	C	12) UPDATED MAIN LIGHT SWITCH	—	—
A2	—	REVISED IAW R2 CHANGES 13) J. QUADERER WAS M. TOWNSEND (2 PLCS)	—	—
A4	D	21) DISTRIBUTION STATEMENT C: WAS A: ERR SSS-U5806	02-07-11	L.RODNEY LJR/SEH
A4	D	21) DISTRIBUTION STATEMENT C: WAS A: ERR SSS-U5882	02-09-18	L.RODNEY ADJ/SEH

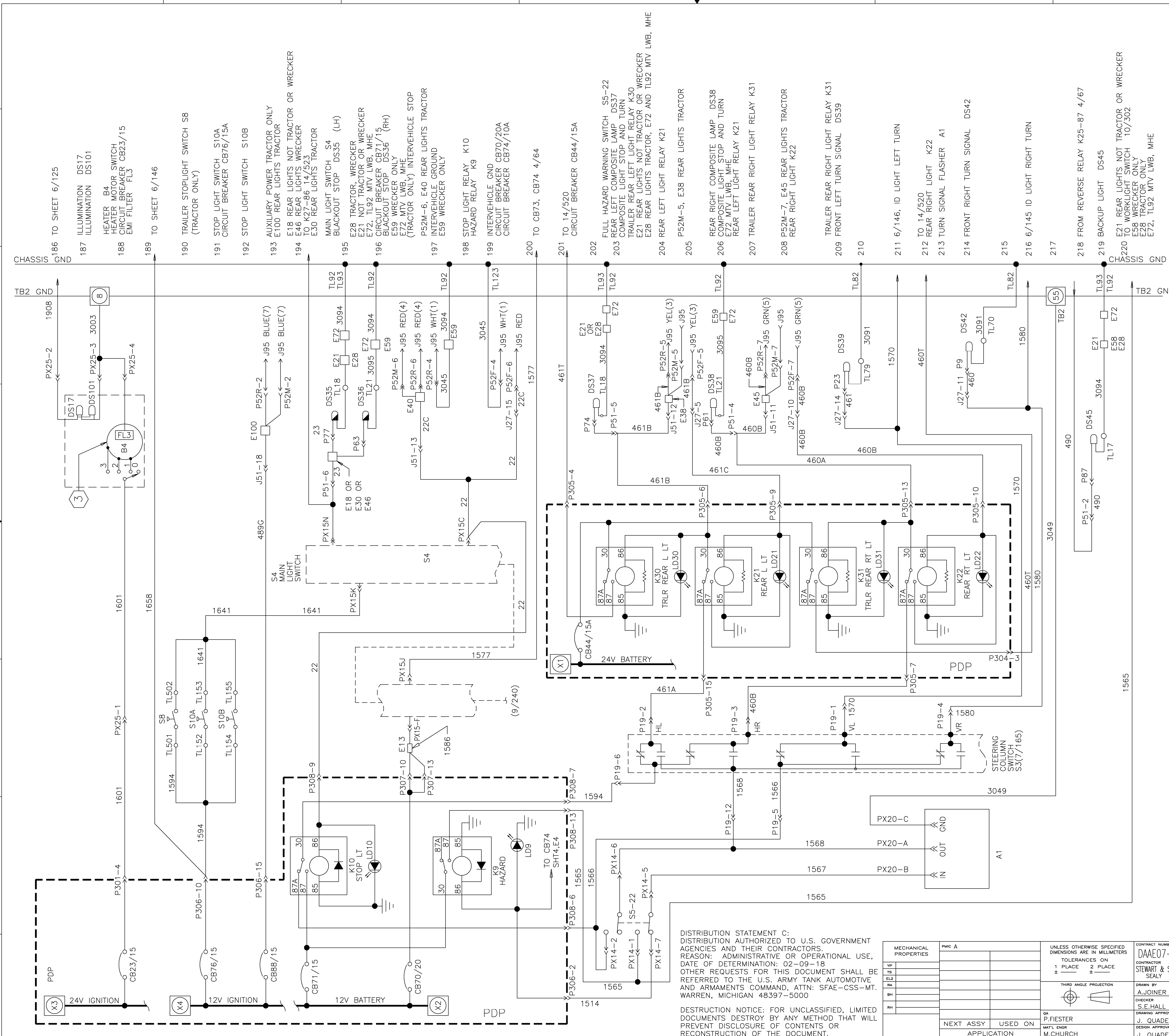

DISTRIBUTION STATEMENT C:
DISTRIBUTION AUTHORIZED TO U.S. GOVERNMENT
AGENCIES AND THEIR CONTRACTORS.
REASON: ADMINISTRATIVE OR OPERATIONAL USE,
DATE OF DETERMINATION: 02-09-18
OTHER REQUESTS FOR THIS DOCUMENT SHALL BE
REFERRED TO THE U.S. ARMY TANK AUTOMOTIVE
AND ARMAMENTS COMMAND, ATTN: SFAE-CSS-MT,
WARREN, MICHIGAN 48397-5000

DESTRUCTION NOTICE: FOR UNCLASSIFIED, LIMITED
DOCUMENTS DESTROY BY ANY METHOD THAT WILL
PREVENT DISCLOSURE OF CONTENTS OR
RECONSTRUCTION OF THE DOCUMENT.

CM APPROVED
1-29-04
PERECP7385R1
DOCUMENT

MECHANICAL PROPERTIES	PMIC A	UNLESS OTHERWISE SPECIFIED DIMENSIONS ARE IN MILLIMETERS	CONTRACT NUMBER DAAE07-99-C-3030		DESIGN ACTIVITY U.S. ARMY, TANK AUTOMOTIVE COMMAND WARREN, MICHIGAN 48397-5000
			TOLERANCES ON 1 PLACE 2 PLACE ± ±		
DA P.FIESTER	MATERIAL M.CHURCH	THIRD ANGLE PROJECTION	DRAWN BY A.JOINER		DATE (YR-MO-DA) 02-02-27
			CHECKER S.E.HALL		
NEXT ASSY USED ON APPLICATION		DESIGN APPROVAL - GOVT J. QUADERER		ENGINEER L.RODNEY	
SCALE NONE		SIZE E 19207		CAGE CODE 12422872	
UNIT WT		SHEET 8		FILE NAME 2872DER.DWG	

I
G
T
E
D
C
B
A

8
7
6
5
4
3
2
1

TACOM-E-METRIC

REVISIONS				
ZONE	REV	DESCRIPTION	DATE	APPROVED
---	---	ALL REVISIONS LISTED ON SH. 1	---	---
---	---	INITIAL RELEASE -PRODUCT BASELINE- ERR SSS-55777	---	---
A6	C	14) UPDATE MAIN LIGHT SWITCH	---	---
A2		REVISED IAW R2 CHANGES 15) J. QUADERER WAS M. TOWNSEND (2 PLCS) ERR SSS-U5806	02-07-11	L.RODNEY LJR/SEH
D7 A7 E7 A4	D	22) ADDED 12V OUTLET WITH ROUTING TO CB85 23) CB85 WAS CB87 & 20A WAS 15A 24) ADDED WIRE# 3200 25) DISTRIBUTION STATEMENT C: WAS A: ERR SSS-U5882	02-09-18	L.RODNEY ADJ/SEH

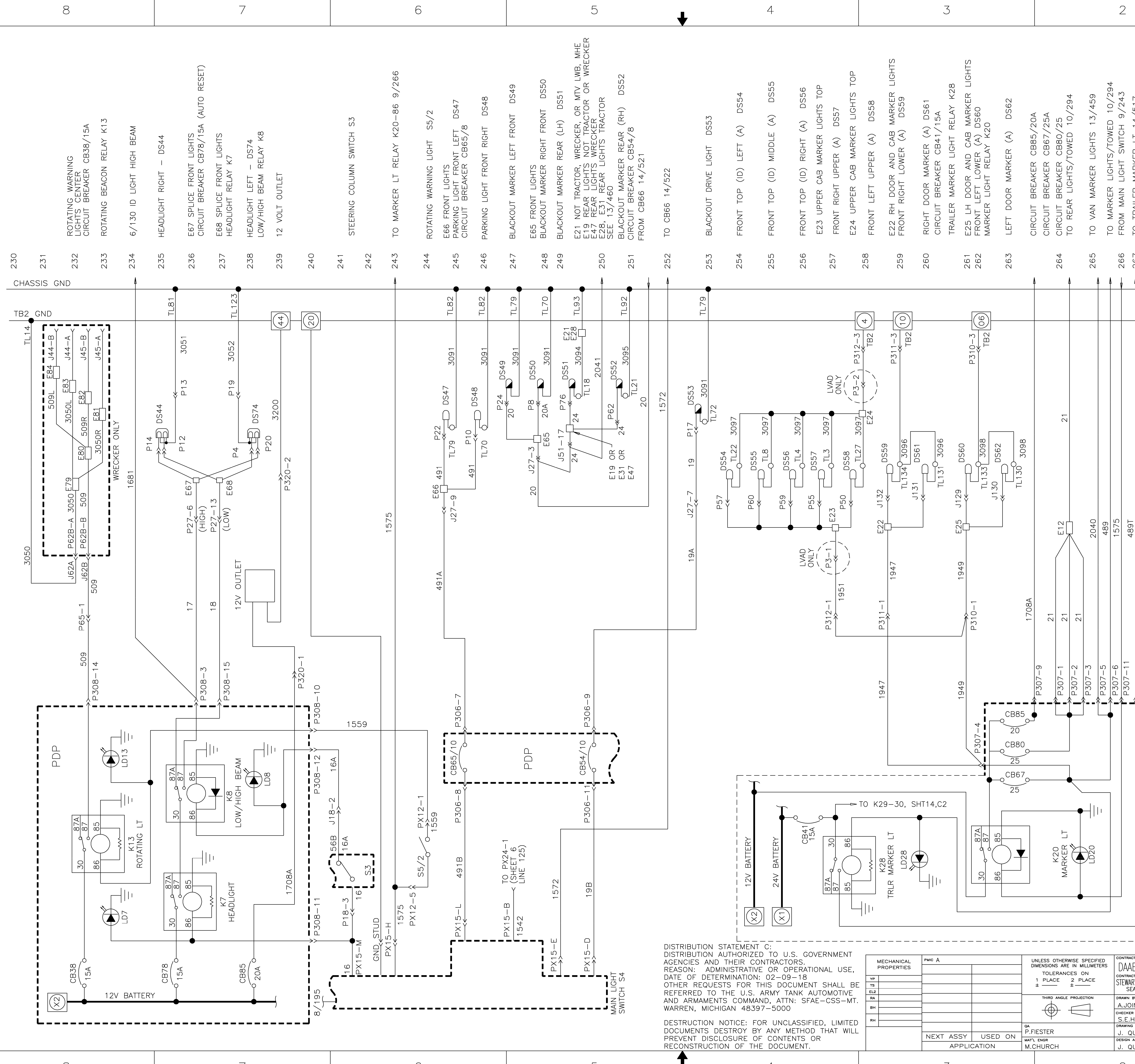

CM APPROVED
1-29-04
PERECP7385R1
DOCUMENT

DISTRIBUTION STATEMENT C:
DISTRIBUTION AUTHORIZED TO U.S. GOVERNMENT
AGENCIES AND THEIR CONTRACTORS.
REASON: ADMINISTRATIVE OR OPERATIONAL USE,
DATE OF DETERMINATION: 02-09-18
OTHER REQUESTS FOR THIS DOCUMENT SHALL BE
REFERRED TO THE U.S. ARMY TANK AUTOMOTIVE
AND ARMAMENTS COMMAND, ATTN: SFAE-CSS-MT,
WARREN, MICHIGAN 48397-5000

DESTRUCTION NOTICE: FOR UNCLASSIFIED, LIMITED
DOCUMENTS DESTROY BY ANY METHOD THAT WILL
PREVENT DISCLOSURE OF CONTENTS OR
RECONSTRUCTION OF THE DOCUMENT.

MECHANICAL PROPERTIES	PMIC A	UNLESS OTHERWISE SPECIFIED DIMENSIONS ARE IN MILLIMETERS TOLERANCES ON 1 PLACE ± 2 PLACE THIRD ANGLE PROJECTION	CONTRACT NUMBER DAAE07-99-C-5030	DESIGN ACTIVITY U.S. ARMY, TANK AUTOMOTIVE COMMAND WARREN, MICHIGAN 48397-5000
	NEXT ASSY		USED ON APPLICATION	CONTRACTOR STEWART & STEVENSON SERVICES SEALY, TEXAS
DRW	J. QUADERER	DATE (YY-MM-DD) 02-02-27	ENGINEER L.RODNEY	SIZE E
CHKD	J. QUADERER	DATE (YY-MM-DD) 02-02-27	ENGINEER L.RODNEY	CAGE CODE 19207
APP'D	J. QUADERER	DATE (YY-MM-DD) 02-02-27	ENGINEER L.RODNEY	DWG NO 12422872
SCALE	NONE	UNIT WT	SHEET	9

REVISIONS				
ZONE	REV	DESCRIPTION	DATE	APPROVED
---	---	ALL REVISIONS LISTED ON SH. 1	---	---
---	---	INITIAL RELEASE - PRODUCT BASELINE - ERR SSS-U5777	---	---
A2	C	REVISED IAW R2 CHANGES 16) J. QUADERER WAS M. TOWNSEND (2 PLCS) ERR SSS-U5806	02-07-11	L.RODNEY LJR/SEH
A4	D	26) DISTRIBUTION STATEMENT C: WAS A: ERR SSS-U5882	02-09-18	L.RODNEY ADJ/SEH

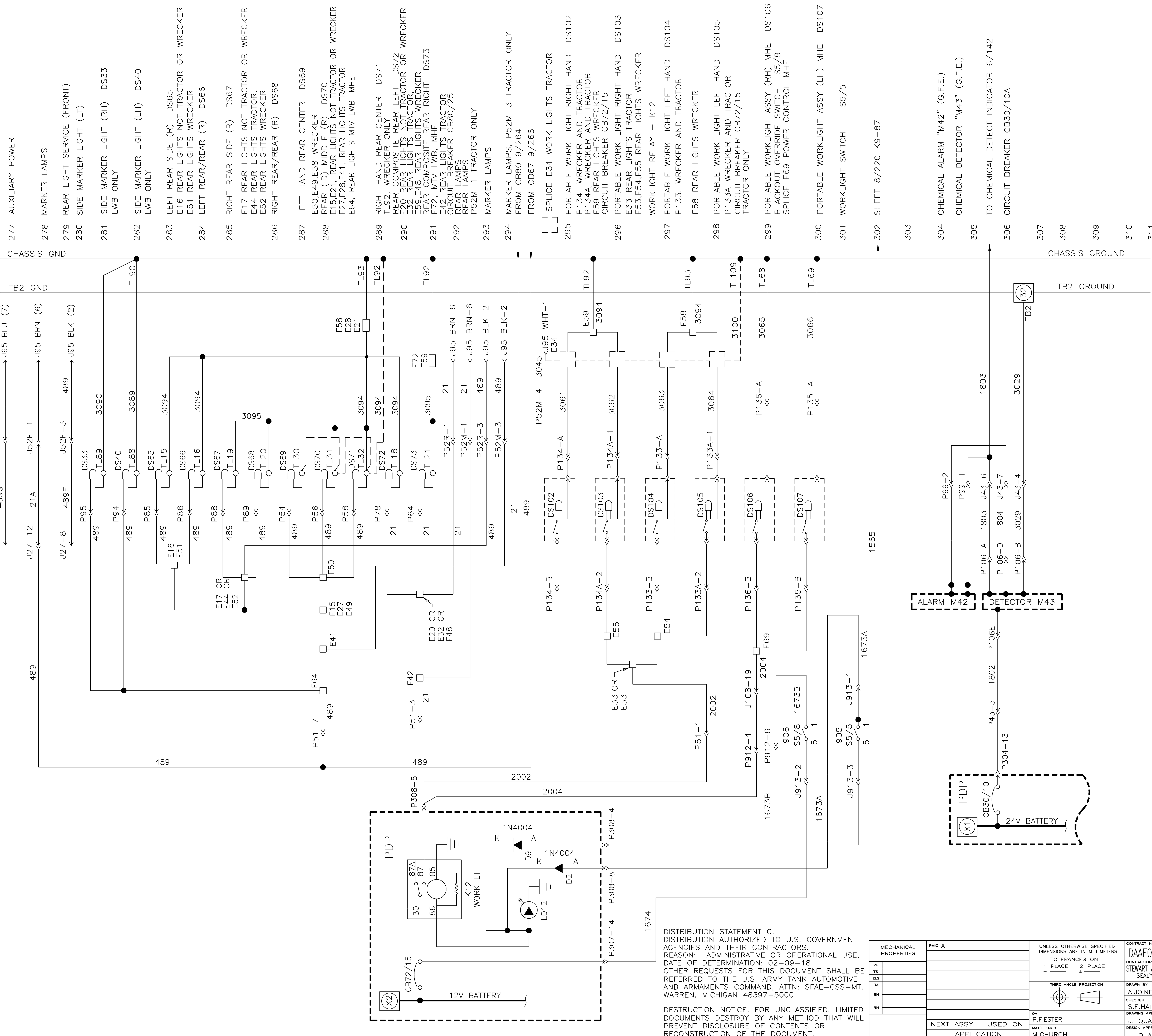

DISTRIBUTION STATEMENT C:
DISTRIBUTION AUTHORIZED TO U.S. GOVERNMENT AGENCIES AND THEIR CONTRACTORS.
REASON: ADMINISTRATIVE OR OPERATIONAL USE.
DATE OF DETERMINATION: 02-09-18
OTHER REQUESTS FOR THIS DOCUMENT SHALL BE REFERRED TO THE U.S. ARMY TANK AUTOMOTIVE AND ARMAMENTS COMMAND, ATTN: SFAE-CSS-MT. WARREN, MICHIGAN 48397-5000

DESTRUCTION NOTICE: FOR UNCLASSIFIED, LIMITED DOCUMENTS DESTROY BY ANY METHOD THAT PREVENT DISCLOSURE OF CONTENTS OR RECONSTRUCTION OF THE DOCUMENT.

MECHANICAL PROPERTIES	PMC A	UNLESS OTHERWISE SPECIFIED DIMENSIONS ARE IN MILLIMETERS
YP		TOLERANCES ON
TS		1 PLACE ±
ELZ		2 PLACE ±
RA		
BH		
THIRD ANGLE PROJECTION		
GA	P.FIESTER	
NEXT ASSY	USED ON	
APPLICATION	M.CHURCH	

CONTRACT NUMBER	DAAE07-99-C-5030	DESIGN ACTIVITY	U.S. ARMY, TANK AUTOMOTIVE COMMAND WARREN, MICHIGAN 48397-5000
CONTRACTOR	STEWART & STEVENSON SERVICES SEELY, TEXAS U.S.A.	DRAWN BY	A.JOINER
CHECKER	S.E.HALL	DATE (YY-MM-DD)	02-02-27
DRAWING APPROVAL - GOVT	J. QUADERER	ENGINEER	L.RODNEY
SCALE	NONE	SIZE	E 19207
UNIT WT		DWG NO	12422872
SHEET	10	FILE NAME	2872DE10

CM APPROVED
1-29-04
PERECP7385R1
DOCUMENT

REVISIONS				
ZONE	REV	DESCRIPTION	DATE	APPROVED
1	1	INITIAL RELEASE - PRODUCT BASELINE - ERR SSS-U5777		
A2	C	REVISED IAW R2 CHANGES (17) J. QUADERER WAS M. TOWNSEND (2 PLCS) ERR SSS-U5806	02-07-11	L.RODNEY
A4	D	DISTRIBUTION STATEMENT C: WAS A: ERR SSS-U5882	02-09-18	ADJ SEH

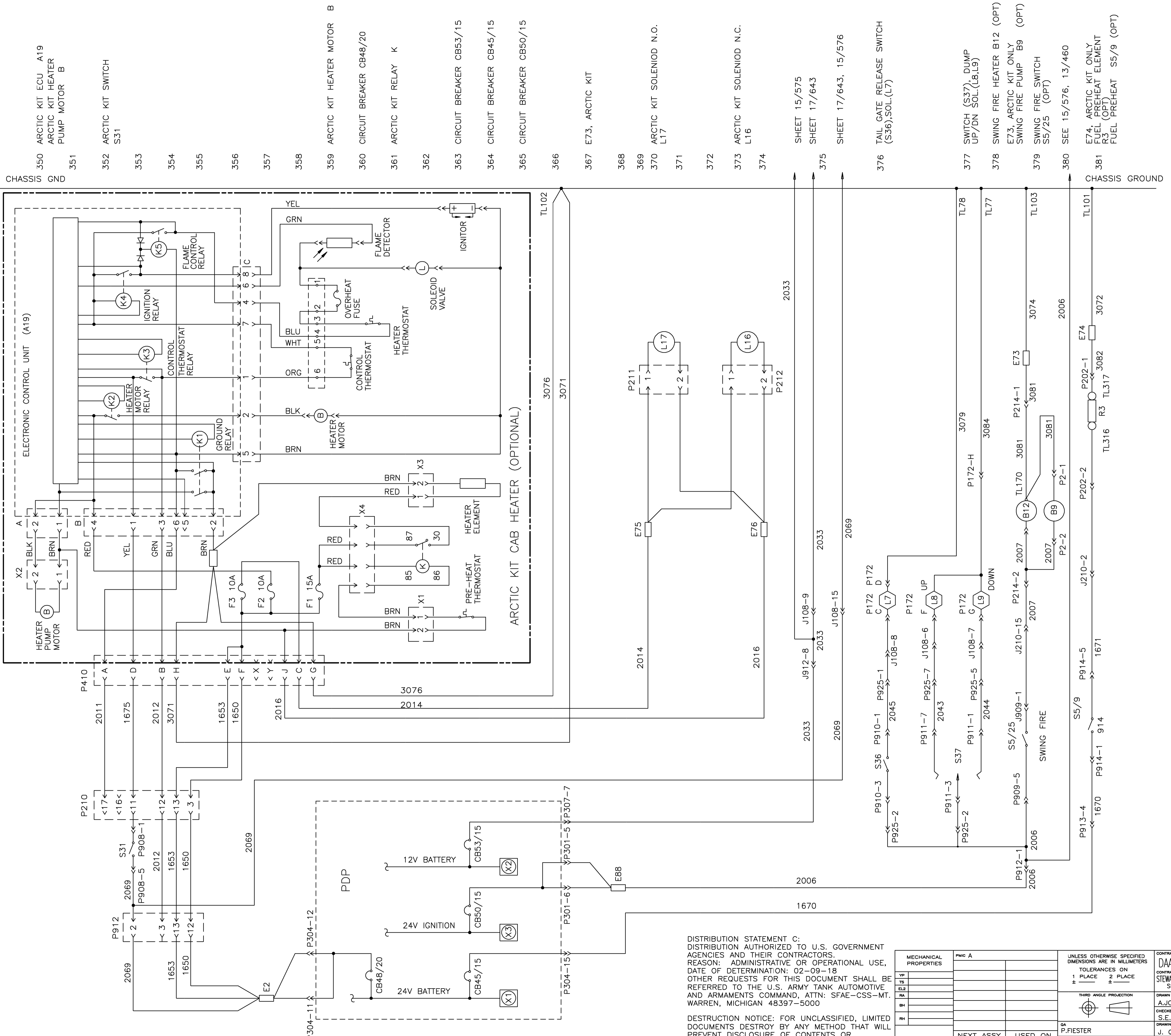

CM APPROVED
1-29-04
PERECP7385R1
DOCUMENT

DISTRIBUTION STATEMENT C:
DISTRIBUTION AUTHORIZED TO U.S. GOVERNMENT AGENCIES AND THEIR CONTRACTORS.
REASON: ADMINISTRATIVE OR OPERATIONAL USE, DATE OF DETERMINATION: 02-09-18
OTHER REQUESTS FOR THIS DOCUMENT SHALL BE REFERRED TO THE U.S. ARMY TANK AUTOMOTIVE AND ARMAMENTS COMMAND, ATTN: SFAE-CSS-MT, WARREN, MICHIGAN 48397-5000

DESTRUCTION NOTICE: FOR UNCLASSIFIED, LIMITED DOCUMENTS DESTROY BY ANY METHOD THAT WILL PREVENT DISCLOSURE OF CONTENTS OR RECONSTRUCTION OF THE DOCUMENT.

MECHANICAL PROPERTIES		PMIC A
VP		
TS		
EL		
RA		
BH		
RH		
DA	P.FIESTER	
MATL ENGR	M.CHURCH	
NEXT ASSY	USED ON	
APPLICATION		

UNLESS OTHERWISE SPECIFIED DIMENSIONS ARE IN MILLIMETERS	
TOLERANCES ON	PLACES
±	1 PLACE
±	2 PLACE
±	3 PLACE
±	4 PLACE
±	5 PLACE
±	6 PLACE
±	7 PLACE
±	8 PLACE
±	9 PLACE
±	10 PLACE
±	11 PLACE
±	12 PLACE
±	13 PLACE
±	14 PLACE
±	15 PLACE
±	16 PLACE
±	17 PLACE
±	18 PLACE
±	19 PLACE
±	20 PLACE
±	21 PLACE
±	22 PLACE
±	23 PLACE
±	24 PLACE
±	25 PLACE
±	26 PLACE
±	27 PLACE
±	28 PLACE
±	29 PLACE
±	30 PLACE
±	31 PLACE
±	32 PLACE
±	33 PLACE
±	34 PLACE
±	35 PLACE
±	36 PLACE
±	37 PLACE
±	38 PLACE
±	39 PLACE
±	40 PLACE
±	41 PLACE
±	42 PLACE
±	43 PLACE
±	44 PLACE
±	45 PLACE
±	46 PLACE
±	47 PLACE
±	48 PLACE
±	49 PLACE
±	50 PLACE
±	51 PLACE
±	52 PLACE
±	53 PLACE
±	54 PLACE
±	55 PLACE
±	56 PLACE
±	57 PLACE
±	58 PLACE
±	59 PLACE
±	60 PLACE
±	61 PLACE
±	62 PLACE
±	63 PLACE
±	64 PLACE
±	65 PLACE
±	66 PLACE
±	67 PLACE
±	68 PLACE
±	69 PLACE
±	70 PLACE
±	71 PLACE
±	72 PLACE
±	73 PLACE
±	74 PLACE
±	75 PLACE
±	76 PLACE
±	77 PLACE
±	78 PLACE
±	79 PLACE
±	80 PLACE
±	81 PLACE
±	82 PLACE
±	83 PLACE
±	84 PLACE
±	85 PLACE
±	86 PLACE
±	87 PLACE
±	88 PLACE
±	89 PLACE
±	90 PLACE
±	91 PLACE
±	92 PLACE
±	93 PLACE
±	94 PLACE
±	95 PLACE
±	96 PLACE
±	97 PLACE
±	98 PLACE
±	99 PLACE
±	100 PLACE

CONTRACT NUMBER		DESIGN ACTIVITY	
DAAE07-99-C-S030		U.S. ARMY, TANK AUTOMOTIVE COMMAND WARREN, MICHIGAN 48397-5000	
CONTRACTOR		DRAWN BY	
STEWART & STEVENSON SERVICES SEALY TEXAS U.S.A.		A.JOINER	
CHECKER		DATE (YY-MM-DD)	
S.E.HALL		02-02-27	
ENGINEER		SCALE	
L.RODNEY		NONE	
DRAWING APPROVAL - GOV'T		CAGE CODE	
J. QUADERER		E 19207	
DESIGN APPROVAL - GOV'T		DWG NO	
J. QUADERER		12422872	
SCALE		SHEET	
NONE		11	

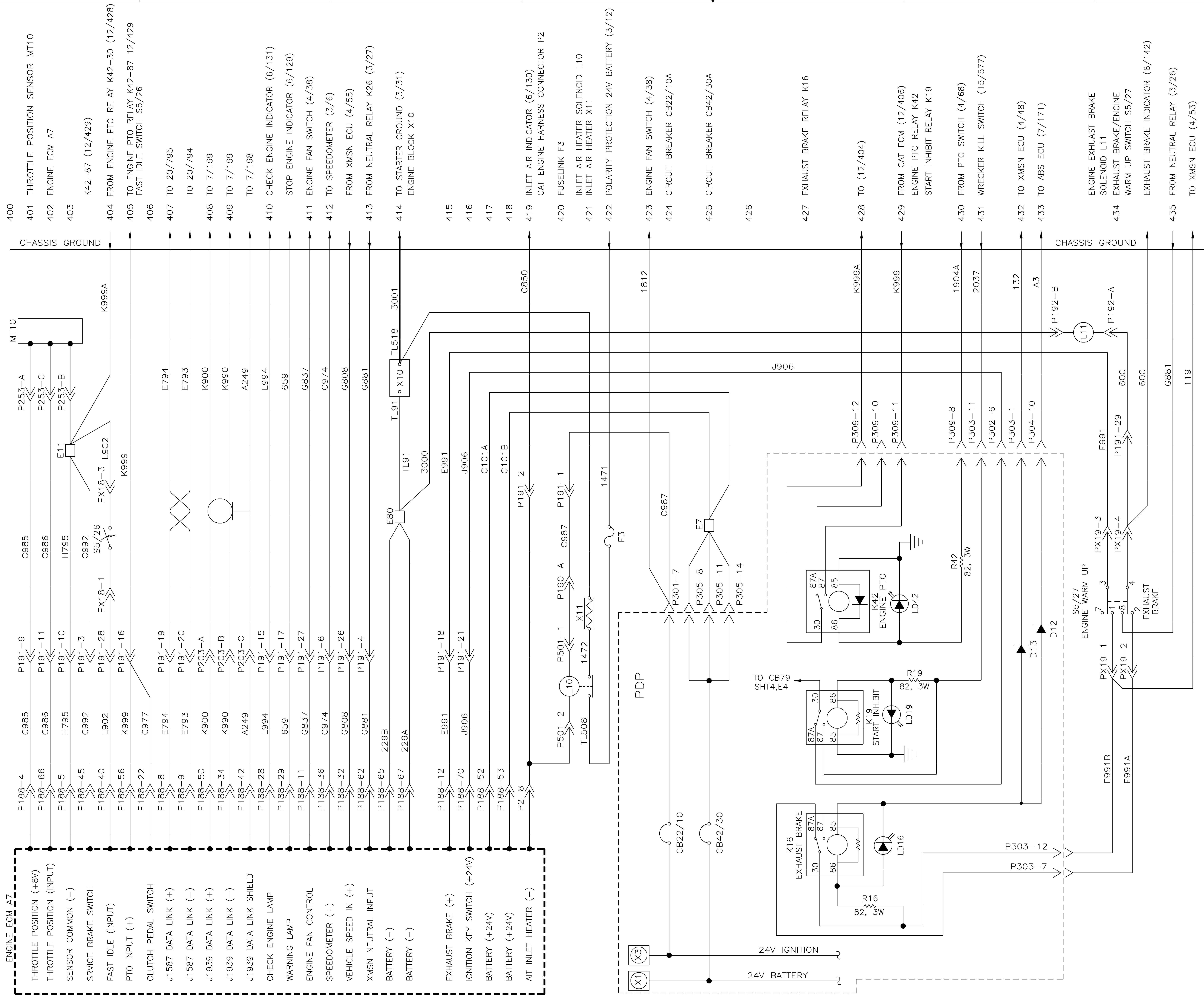

REVISIONS				
ZONE	REV	DESCRIPTION	DATE	APPROVED
---	---	ALL REVISIONS LISTED ON SH. 1	---	---
---	---	INITIAL RELEASE - PRODUCT BASELINE - ERR SSS-U5777	---	---
A2	C	REVISED LAW R2 CHANGES 18) J. QUADERER WAS M. TOWNSEND (2 PLCS)	02-07-11	L.RODNEY LJR/SEH
A4	D	DISTRIBUTION STATEMENT C: WAS A: ERR SSS-U5806	02-09-18	L.RODNEY ADJ/SEH
D6	F	1) REMOVED EMI FLTER ERR SSS-U7390	03-02-12	L.RODNEY LJR/SEH

CM APPROVED
1-29-04
PERECP7385R1
DOCUMENT

DISTRIBUTION STATEMENT C: DISTRIBUTION AUTHORIZED TO U.S. GOVERNMENT AGENCIES AND THEIR CONTRACTORS. REASON: ADMINISTRATIVE OR OPERATIONAL USE, DATE OF DETERMINATION: 02-09-18 OTHER REQUESTS FOR THIS DOCUMENT SHALL BE REFERRED TO THE U.S. ARMY TANK AUTOMOTIVE AND ARMAMENTS COMMAND, ATTN: SFAE-CSS-MT. WARREN, MICHIGAN 48397-5000

DESTRUCTION NOTICE: FOR UNCLASSIFIED, LIMITED DOCUMENTS DESTROY BY ANY METHOD THAT WILL PREVENT DISCLOSURE OF CONTENTS OR RECONSTRUCTION OF THE DOCUMENT.

MECHANICAL PROPERTIES	PMIC A	UNLESS OTHERWISE SPECIFIED DIMENSIONS ARE IN MILLIMETERS TOLERANCES ON 1 PLACE 2 PLACE ± ±	CONTRACT NUMBER DAAE07-99-C-S030	DESIGN ACTIVITY U.S. ARMY, TANK AUTOMOTIVE COMMAND WARREN, MICHIGAN 48397-5000
	YF		CONTRACTOR STEWART & STEVENSON SERVICES SEALY, TEXAS	SCHEMATIC, ELECTRICAL
	TS		DATE (YY-MM-DD) 02-02-27	
ELZ	THIRD ANGLE PROJECTION	DRAWING APPROVAL - GOV'T P.FIESTER	ENGINEER S.E.HALL	CAGE CODE 12422872
RA	GA	MAT'L ENGR M.CHURCH	DESIGN APPROVAL - GOV'T J. QUADERER	SCALE NONE
RE	NEXT ASSY	USED ON APPLICATION	SCALE NONE	UNIT WT
RH				SHEET 12

REVISIONS				
ZONE	REV	DESCRIPTION	DATE	APPROVED
---	---	ALL REVISIONS LISTED ON SH. 1	---	---
---	---	INITIAL RELEASE - PRODUCT BASELINE - ERR SSS-U5777	---	---
A2	C	REVISED IAW R2 CHANGES 19) J. QUADERER WAS M. TOWNSEND (2 PLCS) ERR SSS-U5806	02-07-11	L.RODNEY LJR/SEH
A4	D	29) DISTRIBUTION STATEMENT C: WAS A: ERR SSS-U5882	02-09-18	L.RODNEY ADJ/SEH

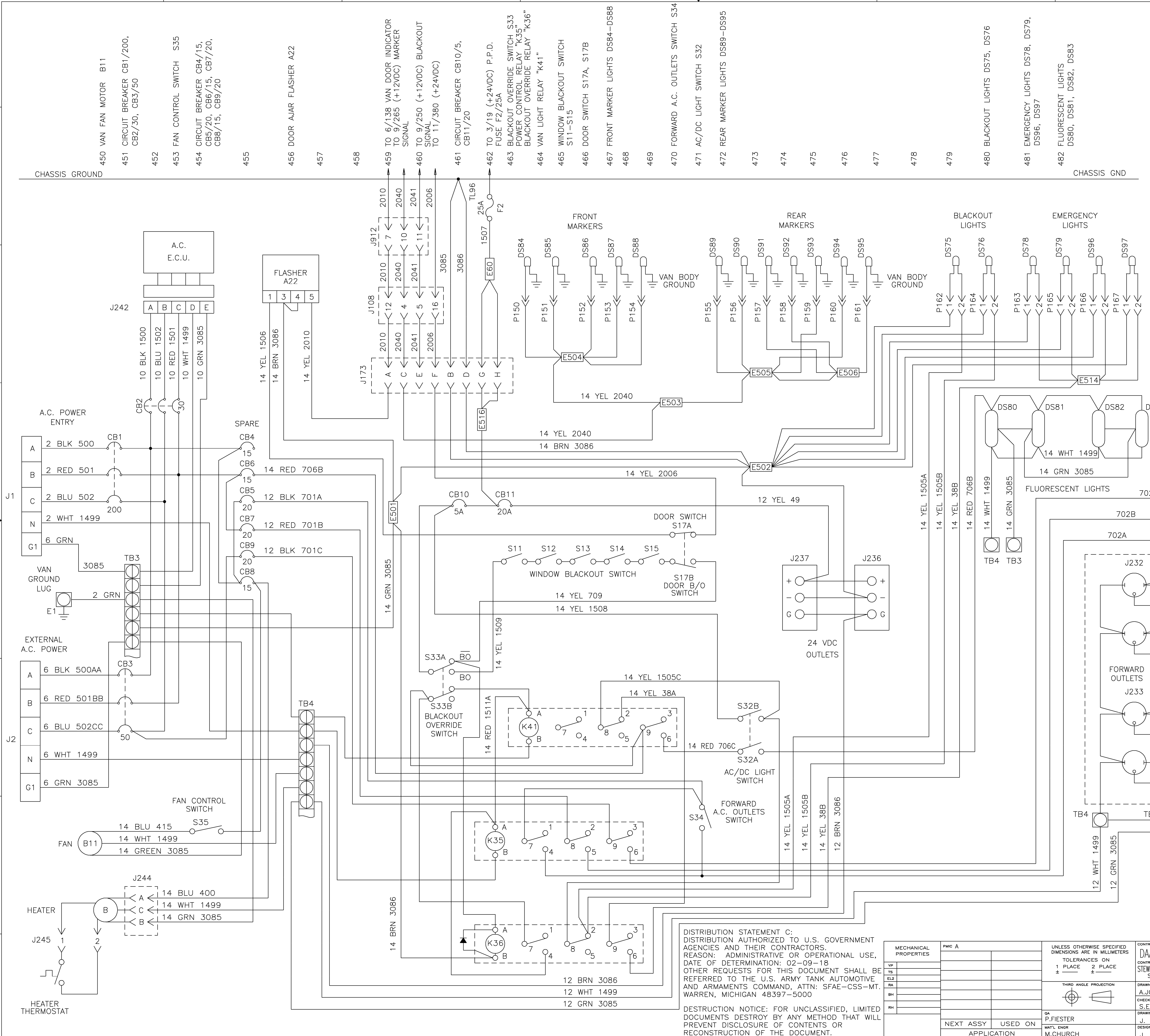

CM APPROVED
1-29-04
PERECP7385R1
DOCUMENT

VAN SCHEMATIC

DISTRIBUTION STATEMENT C:
DISTRIBUTION AUTHORIZED TO U.S. GOVERNMENT AGENCIES AND THEIR CONTRACTORS.
REASON: ADMINISTRATIVE OR OPERATIONAL USE, DATE OF DETERMINATION: 02-09-18
OTHER REQUESTS FOR THIS DOCUMENT SHALL BE REFERRED TO THE U.S. ARMY TANK AUTOMOTIVE AND ARMAMENTS COMMAND, ATTN: SFAE-CSS-MT, WARREN, MICHIGAN 48397-5000

DESTRUCTION NOTICE: FOR UNCLASSIFIED, LIMITED DOCUMENTS DESTROY BY ANY METHOD THAT PREVENT DISCLOSURE OF CONTENTS OR RECONSTRUCTION OF THE DOCUMENT.

MECHANICAL PROPERTIES		PMIC A		UNLESS OTHERWISE SPECIFIED DIMENSIONS ARE IN MILLIMETERS		CONTRACT NUMBER		DESIGN ACTIVITY	
YP	TE			TOLERANCES ON		DAAE07-99-C-5030		U.S. ARMY, TANK AUTOMOTIVE COMMAND	
EL2	RA			1 PLACE ±		CONTRACTOR		WARREN, MICHIGAN 48397-5000	
RA	BI			2 PLACE ±		STEWART & STEVENSON SERVICES			
BI	SH			THIRD ANGLE PROJECTION		ENGINEER		SCHEMATIC, ELECTRICAL	
						S.E.HALL		L.RODNEY	
				DRAWING APPROVAL - GOV'T		DRAWN BY		DATE (YY-MM-DD)	
				P.FIESTER		A.JOINER		02-02-27	
				MATH ENGR		CHECKER		ENGINEER	
				M.CHURCH		J.QUADERER		S.E.HALL	
				NEXT ASSY		USED ON		SIZE	
				APPLICATION				E 19207	
								CAGE CODE	
								12422872	
								SCALE	
								NONE	
								UNIT WT	
								SHEET	
								13	
								FILE NAME	
								2872DE13.DWG	
								TACOM-E-METRIC	

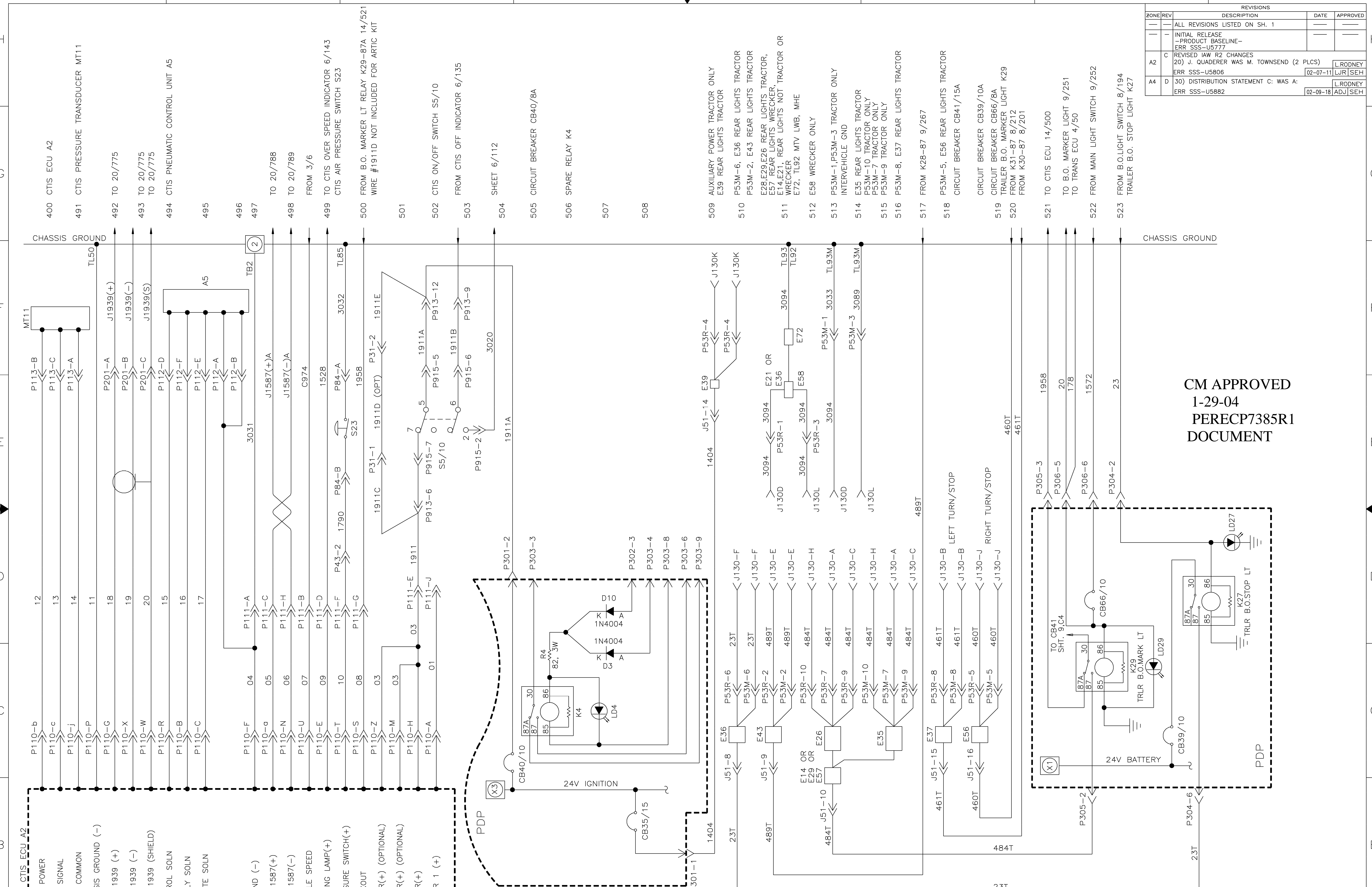

REVISIONS				
ZONE	REV	DESCRIPTION	DATE	APPROVED
---	---	ALL REVISIONS LISTED ON SH. 1	---	---
---	---	INITIAL RELEASE - PRODUCT BASELINE - ERR SSS-U5777	---	---
A2	C	REVISED IAW R2 CHANGES 20) J. QUADERER WAS M. TOWNSEND (2 PLCS)	02-07-11	L.RODNEY LJR/SEH
A4	D	30) DISTRIBUTION STATEMENT C: WAS A: ERR SSS-U5882	02-09-18	L.RODNEY ADJ/SEH

CM APPROVED
1-29-04
PERECP7385R1
DOCUMENT

DISTRIBUTION STATEMENT C:
DISTRIBUTION AUTHORIZED TO U.S. GOVERNMENT AGENCIES AND THEIR CONTRACTORS.
REASON: ADMINISTRATIVE OR OPERATIONAL USE, DATE OF DETERMINATION: 02-09-18
OTHER REQUESTS FOR THIS DOCUMENT SHALL BE REFERRED TO THE U.S. ARMY TANK AUTOMOTIVE AND ARMAMENTS COMMAND, ATTN: SFAE-CSS-MT, WARREN, MICHIGAN 48397-5000

DESTRUCTION NOTICE: FOR UNCLASSIFIED, LIMITED DOCUMENTS DESTROY BY ANY METHOD THAT WILL PREVENT DISCLOSURE OF CONTENTS OR RECONSTRUCTION OF THE DOCUMENT.

MECHANICAL PROPERTIES	PMIC A	UNLESS OTHERWISE SPECIFIED DIMENSIONS ARE IN MILLIMETERS TOLERANCES ON 1 PLACE 2 PLACE ± ±	CONTRACT NUMBER DAAE07-99-C-3030	DESIGN ACTIVITY U.S. ARMY, TANK AUTOMOTIVE COMMAND WARREN, MICHIGAN 48397-5000
	CONTRACTOR STEWART & STEVENSON SERVICES SEALY, TEXAS		DATE (YY-MM-DD) 02-02-27	ENGINEER L.RODNEY
THIRD ANGLE PROJECTION	DA P.FIESTER MATHL ENGR M.CHURCH	DRAWING APPROVAL - GOV'T J. QUADERER	SIZE E 19207	CAGE CODE 12422872
NEXT ASSY APPLICATION	USED ON	SCALE NONE	UNIT WT	SHEET 14

REVISIONS				
ZONE	REV	DESCRIPTION	DATE	APPROVED
		ALL REVISION LISTED ON SH. 1		
		INITIAL RELEASE		
		- PRODDUCT BASELINE -		
		ERR SSS-U5777		
A2	C	REVISED IAW R2 CHANGES 21) J. QUADERER WAS M. TOWNSEND (2 PLCS) ERR SSS-U5806	02-07-11	L.RODNEY LJR/SEH
A4 G5	D	31) DISTRIBUTION STATEMENT C: WAS A: 32) WRECKER CONTROL PANEL WAS IN ZONE A5 ERR SSS-U5862	02-09-18	L.RODNEY ADJ/SEH

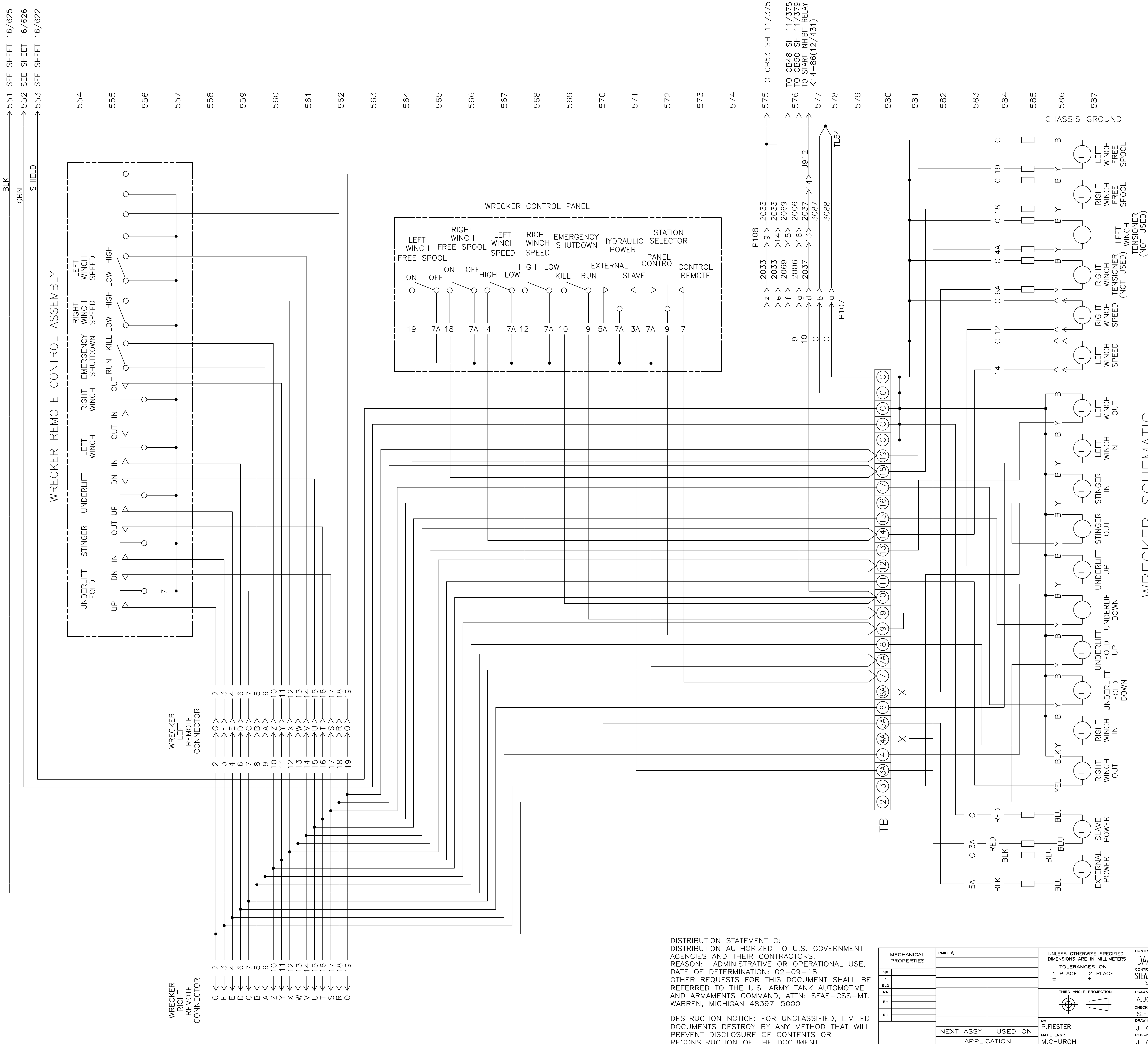

WRECKER SCHEMATIC

DISTRIBUTION STATEMENT C:
DISTRIBUTION AUTHORIZED TO U.S. GOVERNMENT AGENCIES AND THEIR CONTRACTORS.
REASON: ADMINISTRATIVE OR OPERATIONAL USE, DATE OF DETERMINATION: 02-09-18
OTHER REQUESTS FOR THIS DOCUMENT SHALL BE REFERRED TO THE U.S. ARMY TANK AUTOMOTIVE AND ARMAMENTS COMMAND, ATTN: SFAE-CSS-MT, WARREN, MICHIGAN 48397-5000

DESTRUCTION NOTICE: FOR UNCLASSIFIED, LIMITED DOCUMENTS DESTROY BY ANY METHOD THAT WILL PREVENT DISCLOSURE OF CONTENTS OR RECONSTRUCTION OF THE DOCUMENT.

CM APPROVED
1-29-04
PERECP7385R1
DOCUMENT

MECHANICAL PROPERTIES	PMIC A	UNLESS OTHERWISE SPECIFIED DIMENSIONS ARE IN MILLIMETERS TOLERANCES ON 1 PLACE 2 PLACE ± ±	CONTRACT NUMBER DAAE07-99-C-030	DESIGN ACTIVITY U.S. ARMY, TANK AUTOMOTIVE COMMAND WARREN, MICHIGAN 48397-5000
			CONTRACTOR STEWART & STEVENSON SERVICES SEALY, TEXAS	SCHEMATIC, ELECTRICAL
DA	P.FIESTER	THIRD ANGLE PROJECTION	DRAWN BY A.JOINER	DATE (YY-MO-DA) 02-02-27
EL2			CHECKER S.E.HALL	ENGINEER L.RODNEY
RA			DA	J. QUADERER
BH			DESIGN APPROVAL - GOV'T	J. QUADERER
RI			SCALE	NONE
	NEXT ASSY	USED ON	SIZE	E 19207
	APPLICATION		UNIT WT	12422872
			SHEET	15

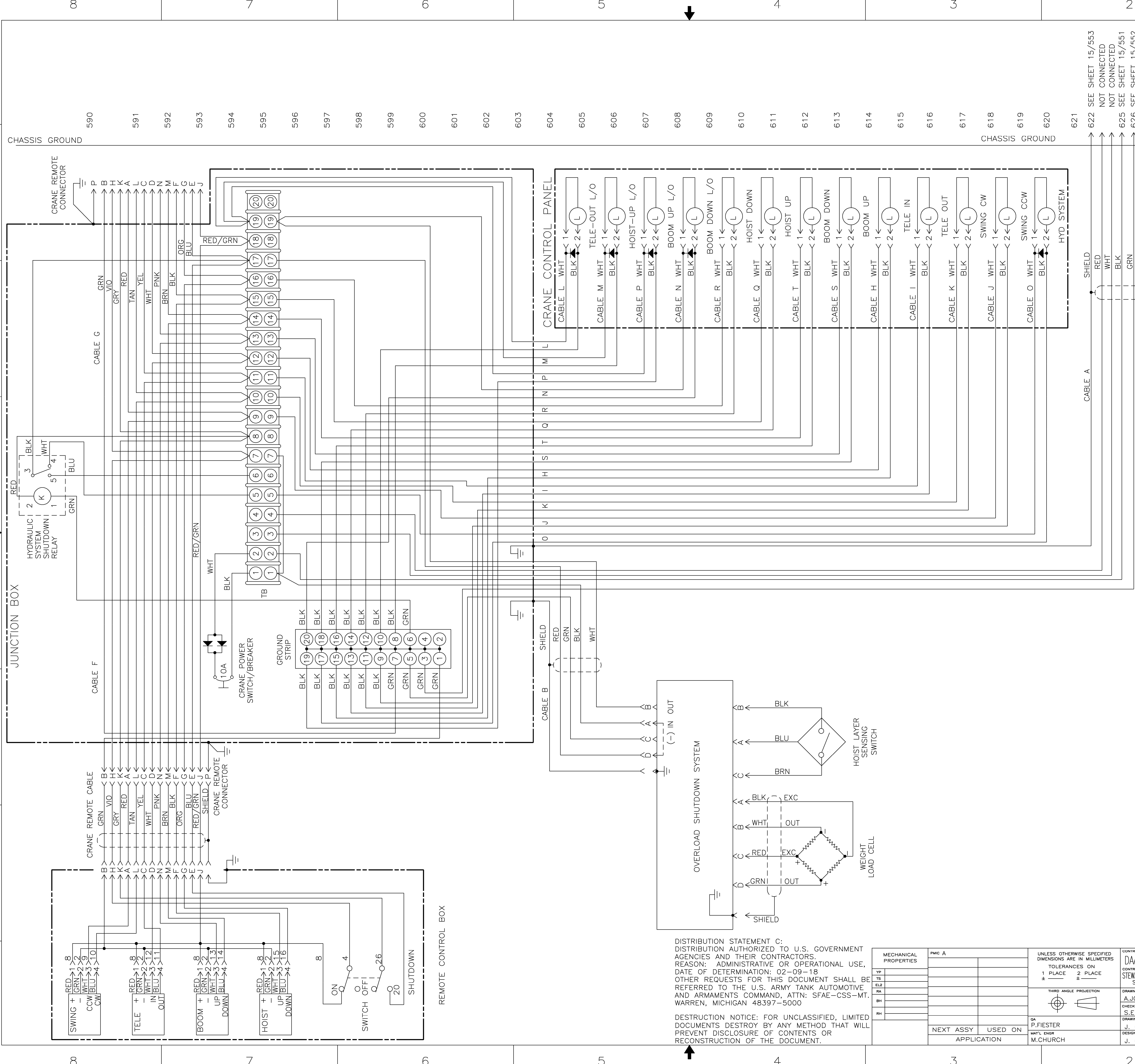

REVISIONS				
ZONE	REV	DESCRIPTION	DATE	APPROVED
---	---	ALL REVISION LISTED ON SH. 1	---	---
---	---	INITIAL RELEASE - PRODUCT BASELINE - ERR SSS-U5777	---	---
A2	C	REVISED IAW R2 CHANGES 22) J. QUADERER WAS M. TOWNSEND (2 PLCS)	02-07-11	L.RODNEY LJR/SEH
A4	D	33) DISTRIBUTION STATEMENT C: WAS A: ERR SSS-U5882	02-09-18	L.RODNEY ADJ/SEH

WRECKER MATERIAL HANDLING CRANE

CM APPROVED
1-29-04
PERECP7385R1
DOCUMENT

DISTRIBUTION STATEMENT C:
DISTRIBUTION AUTHORIZED TO U.S. GOVERNMENT
AGENCIES AND THEIR CONTRACTORS.
REASON: ADMINISTRATIVE OR OPERATIONAL USE.
DATE OF DETERMINATION: 02-09-18
OTHER REQUESTS FOR THIS DOCUMENT SHALL BE
REFERRED TO THE U.S. ARMY TANK AUTOMOTIVE
AND ARMAMENTS COMMAND, ATTN: SFAE-CSS-MT.
WARREN, MICHIGAN 48397-5000

DESTRUCTION NOTICE: FOR UNCLASSIFIED, LIMITED
DOCUMENTS DESTROY BY ANY METHOD THAT WILL
PREVENT DISCLOSURE OF CONTENTS OR
RECONSTRUCTION OF THE DOCUMENT.

MECHANICAL PROPERTIES	PMIC A	UNLESS OTHERWISE SPECIFIED DIMENSIONS ARE IN MILLIMETERS	CONTRACT NUMBER	DESIGN ACTIVITY	
			DAAE07-99-C-5030	U.S. ARMY, TANK AUTOMOTIVE COMMAND WARREN, MICHIGAN 48397-5000	
		TOLERANCES ON	CONTRACTOR	SCHEMATIC, ELECTRICAL	
		1 PLACE ±	STEWART & STEVENSON SERVICES SEALY, TEXAS		
		2 PLACE ±	DRAWN BY	DATE (YY-MM-DD)	
			A. JOINER	02-02-27	
		THIRD ANGLE PROJECTION	CHECKER	ENGINEER	
			S.E. HALL	L. RODNEY	
			DA	DRAWING APPROVAL - GOV'T	SIZE
			P. FIESTER	J. QUADERER	E 19207
			MAT'L ENGR	J. QUADERER	CAGE CODE
			M. CHURCH	J. QUADERER	12422872
				DESIGN APPROVAL - GOV'T	DWG NO
				J. QUADERER	12422872
NEXT ASSY	USED ON	SCALE	NONE	UNIT WT	SHEET
APPLICATION					16

REVISIONS				
ZONE	REV	DESCRIPTION	DATE	APPROVED
		ALL REVISION LISTED ON SH. 1		
		INITIAL RELEASE -PRODDUCT BASELINE- ERR SSS-U5777		
A2	C	REVISED IAW R2 CHANGES 23) J. QUADERER WAS M. TOWNSEND (2 PLCS) ERR SSS-U5806	02-07-11	L.RODNEY LJR/SEH
A4	D	DISTRIBUTION STATEMENT C: WAS A: ERR SSS-U5882	02-09-18	L.RODNEY ADJ/SEH

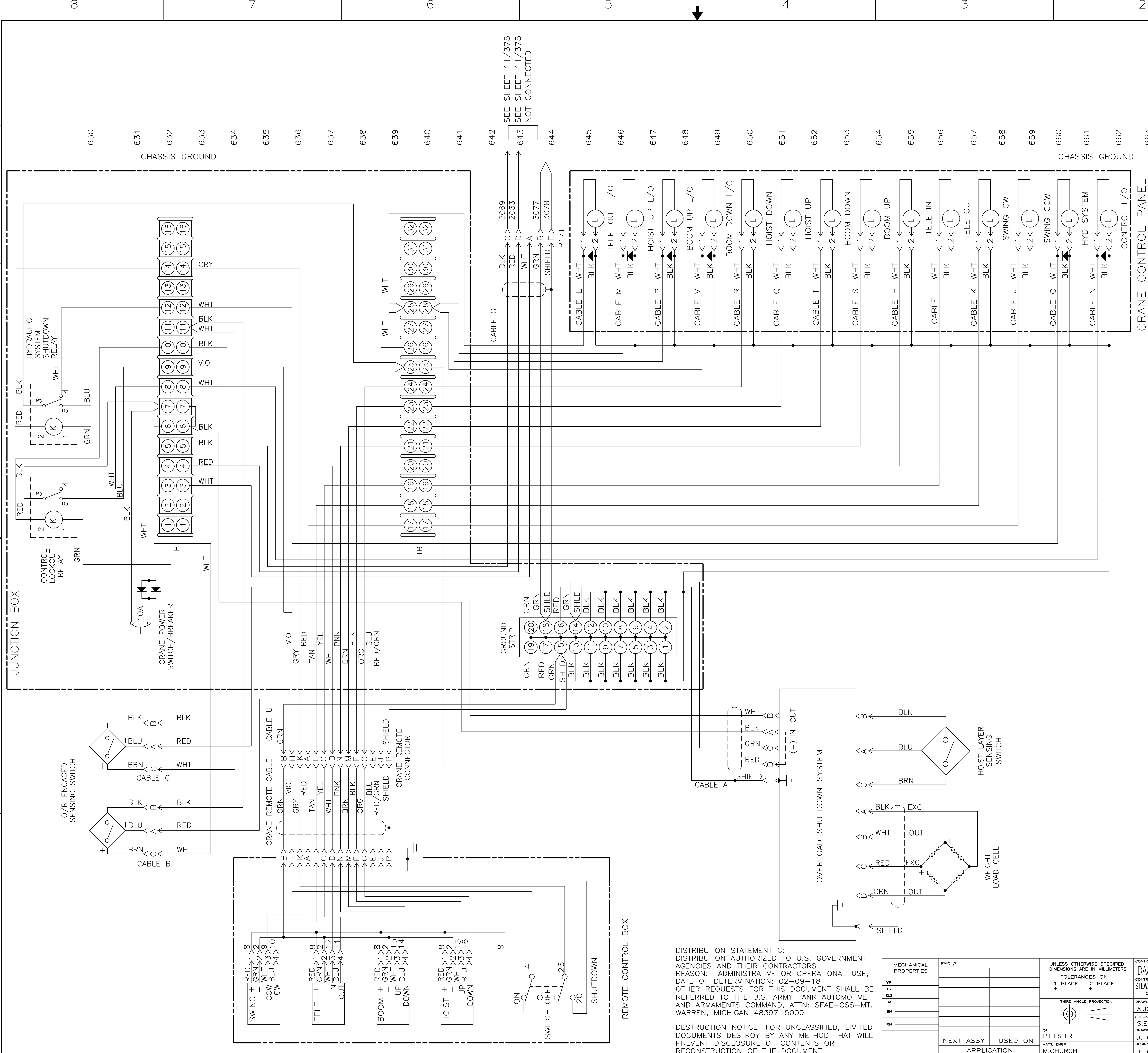

CARGO MATERIAL HANDLING CRANE

CM APPROVED
1-29-04
PERECP7385R1
DOCUMENT

DISTRIBUTION STATEMENT C:
DISTRIBUTION AUTHORIZED TO U.S. GOVERNMENT AGENCIES AND THEIR CONTRACTORS.
REASON: ADMINISTRATIVE OR OPERATIONAL USE.
DATE OF DETERMINATION: 02-09-18
OTHER REQUESTS FOR THIS DOCUMENT SHALL BE REFERRED TO THE U.S. ARMY TANK AUTOMOTIVE AND ARMAMENTS COMMAND, ATTN: SFAE-CSS-MT. WARREN, MICHIGAN 48397-5000

DESTRUCTION NOTICE: FOR UNCLASSIFIED, LIMITED DOCUMENTS DESTROY BY ANY METHOD THAT WILL PREVENT DISCLOSURE OF CONTENTS OR RECONSTRUCTION OF THE DOCUMENT.

MECHANICAL PROPERTIES	PMIC A	UNLESS OTHERWISE SPECIFIED DIMENSIONS ARE IN MILLIMETERS	CONTRACT NUMBER	DAAE07-99-C-030	DESIGN ACTIVITY	U.S. ARMY, TANK AUTOMOTIVE COMMAND WARREN, MICHIGAN 48397-5000
	YP		TOLERANCES ON	CONTRACTOR	STEWART & STEVENSON SERVICES SEALY, TEXAS	SCHEMATIC, ELECTRICAL
TS	1 PLACE	2 PLACE	DRAWN BY	A.JOINER	DATE (YY-MM-DD)	
EL2	±	±	CHECKER	S.E.HALL	ENGINEER	L.RODNEY
RA			THIRD ANGLE PROJECTION	DRAWING APPROVAL - GOV'T		
RI				P.FIESTER		
RR				MATH ENGR		
				M.CHURCH		
	NEXT ASSY	USED ON	DESIGN APPROVAL - GOV'T	J. QUADERER		
	APPLICATION			SCALE	NONE	UNIT WT
				SIZE	E 19207	DWG NO
						12422872
				SHEET		17

REVISIONS				
ZONE	REV	DESCRIPTION	DATE	APPROVED
---	---	ALL REVISION LISTED ON SH. 1	---	---
---	---	INITIAL RELEASE - PRODUCT BASELINE - ERR SSS-U5777	---	---
A2	C	REVISED JAW R2 CHANGES 24) J. QUADERER WAS M. TOWNSEND (2 PLCS) ERR SSS-U5806	02-07-11	L.RODNEY LJR/SEH
A4	D	35) DISTRIBUTION STATEMENT C: WAS A: ERR SSS-U5882	02-09-18	L.RODNEY ADJ/SEH

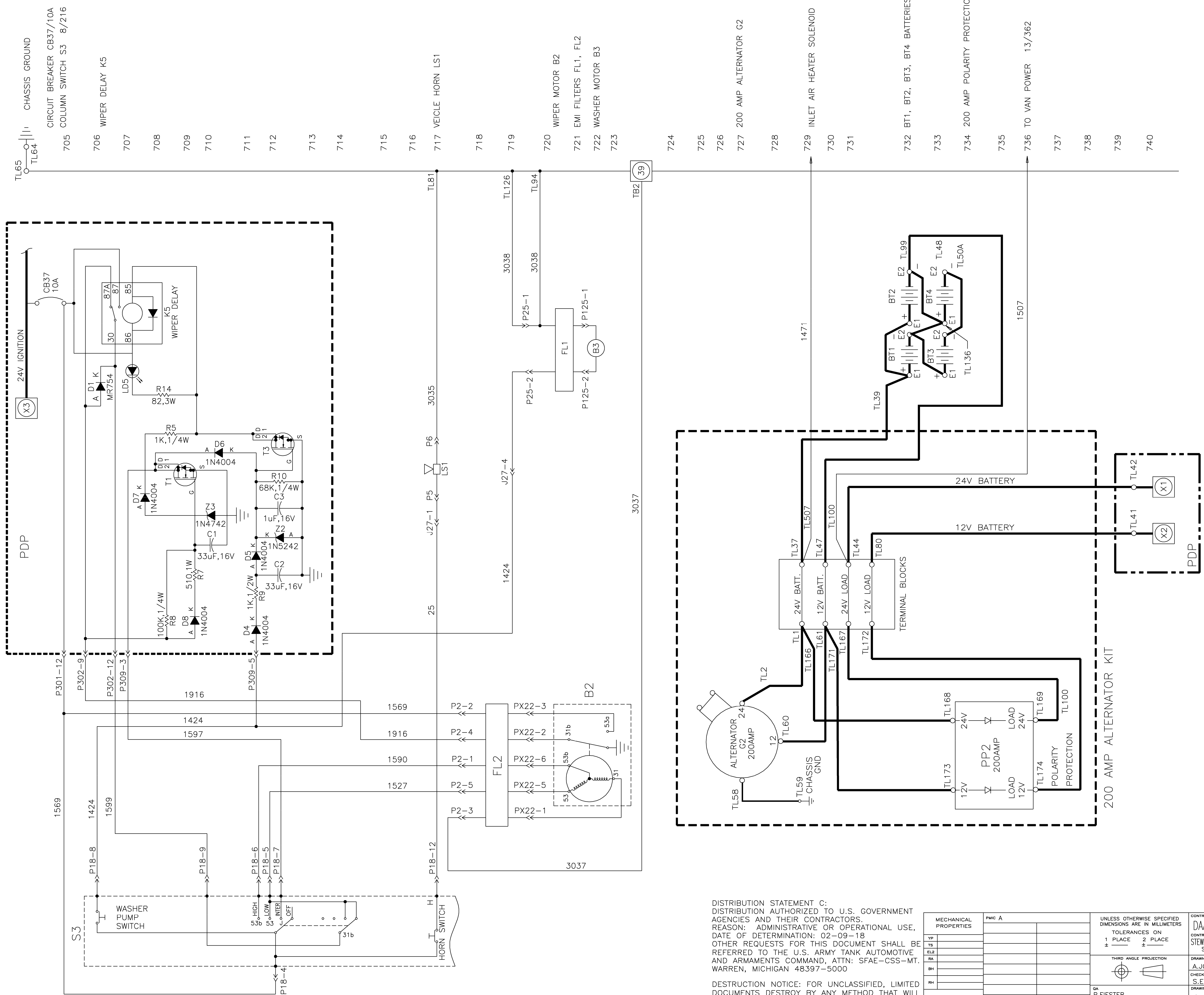

CM APPROVED
1-29-04
PERECP7385R1
DOCUMENT

DISTRIBUTION STATEMENT C:
DISTRIBUTION AUTHORIZED TO U.S. GOVERNMENT
AGENCIES AND THEIR CONTRACTORS.
REASON: ADMINISTRATIVE OR OPERATIONAL USE,
DATE OF DETERMINATION: 02-09-18
OTHER REQUESTS FOR THIS DOCUMENT SHALL BE
REFERRED TO THE U.S. ARMY TANK AUTOMOTIVE
AND ARMAMENTS COMMAND, ATTN: SFAE-CSS-MT,
WARREN, MICHIGAN 48397-5000

DESTRUCTION NOTICE: FOR UNCLASSIFIED, LIMITED
DOCUMENTS DESTROY BY ANY METHOD THAT WILL
PREVENT DISCLOSURE OF CONTENTS OR
RECONSTRUCTION OF THE DOCUMENT.

MECHANICAL PROPERTIES	PMIC A	UNLESS OTHERWISE SPECIFIED DIMENSIONS ARE IN MILLIMETERS	TOLERANCES ON		CONTRACT NUMBER DAAE07-99-C-5030	DESIGN ACTIVITY U.S. ARMY, TANK AUTOMOTIVE COMMAND WARREN, MICHIGAN 48397-5000
			1 PLACE	2 PLACE		
YB		THIRD ANGLE PROJECTION	DRAWN BY A. JOINER	DATE (YR-MO-DA) 02-02-27	CHECKER S.E. HALL	ENGINEER L. RODNEY
RB						
EL		DA P. FIESTER	DRAWING APPROVAL - GOV'T J. QUADERER	SCALE NONE	SIZE E	CAGE CODE 19207
RL						
BN		MATERIAL ENGR M. CHURCH	DESIGN APPROVAL - GOV'T J. QUADERER	UNIT WT	DWG NO 12422872	SHEET 18
BR						
NEXT ASSY USED ON APPLICATION			SCALE	UNIT WT	DWG NO	SHEET

REVISIONS				
ZONE	REV	DESCRIPTION	DATE	APPROVED
---	---	ALL REVISIONS LISTED ON SH. 1	---	---
---	---	INITIAL RELEASE - PRODUCT BASELINE - ERR SSS-U5777	---	---
A2	C	REVISED IAW R2 CHANGES 25) J. QUADERER WAS M. TOWNSEND (2 PLCS)	02-07-11	L.RODNEY
A4	D	36) DISTRIBUTION STATEMENT C: WAS A: ERR SSS-U5882	02-09-18	ADJ/SEH

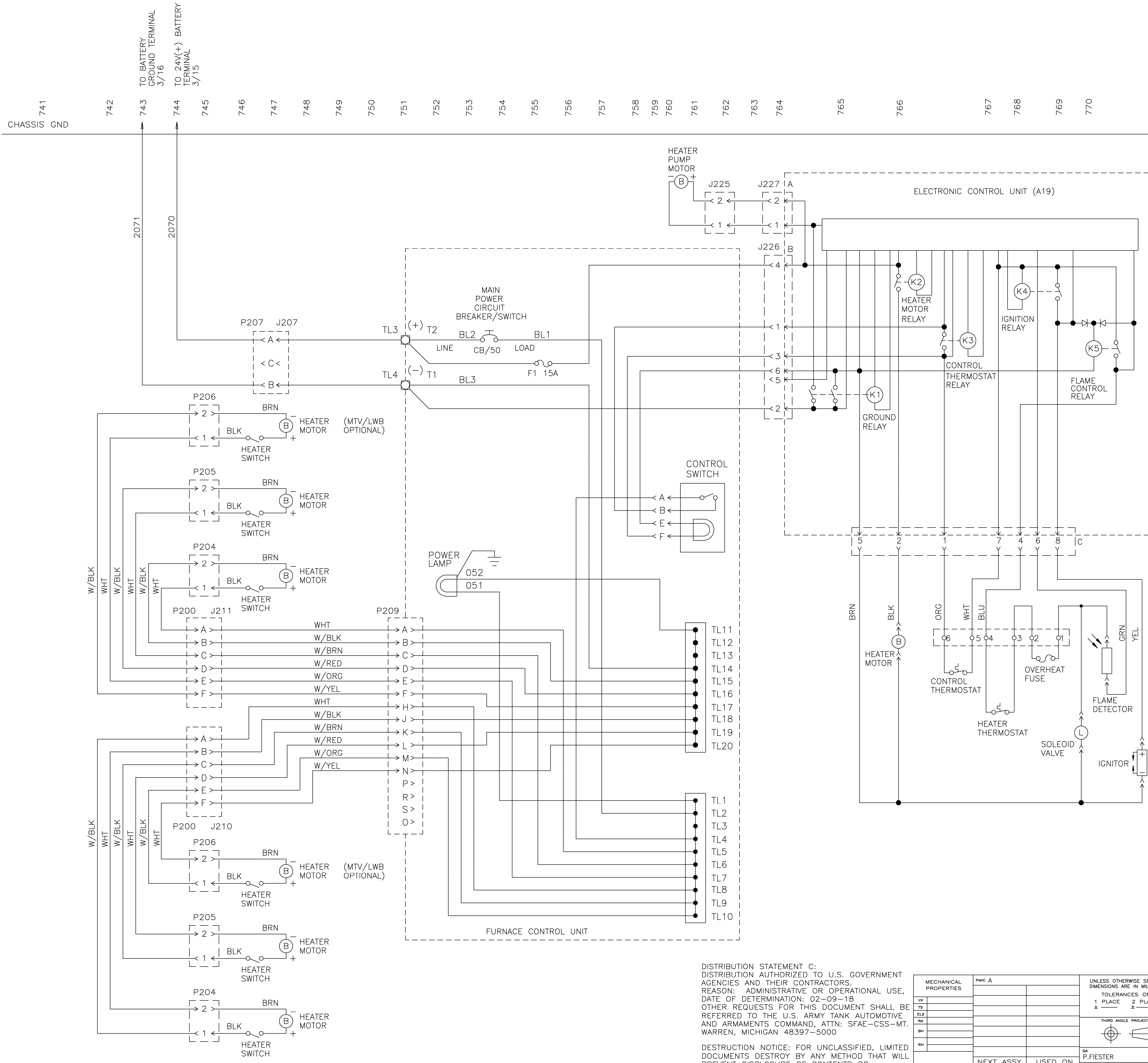

ARCTIC KIT TROOP HEATER (OPTIONAL)

CM APPROVED
1-29-04
PERECP7385R1
DOCUMENT

DISTRIBUTION STATEMENT C:
 DISTRIBUTION AUTHORIZED TO U.S. GOVERNMENT AGENCIES AND THEIR CONTRACTORS.
 REASON: ADMINISTRATIVE OR OPERATIONAL USE.
 DATE OF DETERMINATION: 02-09-18
 OTHER REQUESTS FOR THIS DOCUMENT SHALL BE REFERRED TO THE U.S. ARMY TANK AUTOMOTIVE AND ARMAMENTS COMMAND, ATTN: SFAE-CSS-MT. WARREN, MICHIGAN 48397-5000

DESTRUCTION NOTICE: FOR UNCLASSIFIED, LIMITED DOCUMENTS DESTROY BY ANY METHOD THAT WILL PREVENT DISCLOSURE OF CONTENTS OR RECONSTRUCTION OF THE DOCUMENT.

MECHANICAL PROPERTIES	PMIC A	UNLESS OTHERWISE SPECIFIED TOLERANCES ON 1 PLACE 2 PLACE ± ±	CONTRACT NUMBER DAAE07-99-C-5030	DESIGN ACTIVITY U.S. ARMY TANK AUTOMOTIVE COMMAND WARREN, MICHIGAN 48397-5000
	YP YS EL2 RA RH		THIRD ANGLE PROJECTION	CONTRACTOR STEWART & STEVENSON SERVICES SEALY, TEXAS, U.S.A.
NEXT ASSY USED ON APPLICATION		DA P.FIESTER MAYL ENGR M.CHURCH	DRAWN BY A.JOINER CHECKER S.E.HALL ENGINEER L.RODNEY	DATE (YY-MM-DD) 02-02-27
		GA P.FIESTER	DRAWING APPROVAL - GOV'T J. QUADERER	SIZE E 19207
			DESIGN APPROVAL - GOV'T J. QUADERER	CAGE CODE 12422872
				SCALE NONE
				UNIT WT ---
				SHEET 19

REVISIONS				
ZONE	REV	DESCRIPTION	DATE	APPROVED
---	---	ALL REVISION LISTED ON SH. 1	---	---
---	---	INITIAL RELEASE - PRODUCT BASELINE - ERR SSS-U5777	---	---
A2	C	REVISED LAW R2 CHANGES 25) J. QUADERER WAS M. TOWNSEND (2 PLCS) ERR SSS-U5806	02-07-11	L.RODNEY LJR/SEH
A4	D	37) DISTRIBUTION STATEMENT C: WAS A: ERR SSS-U5882	02-09-18	L.RODNEY ADJ/SEH

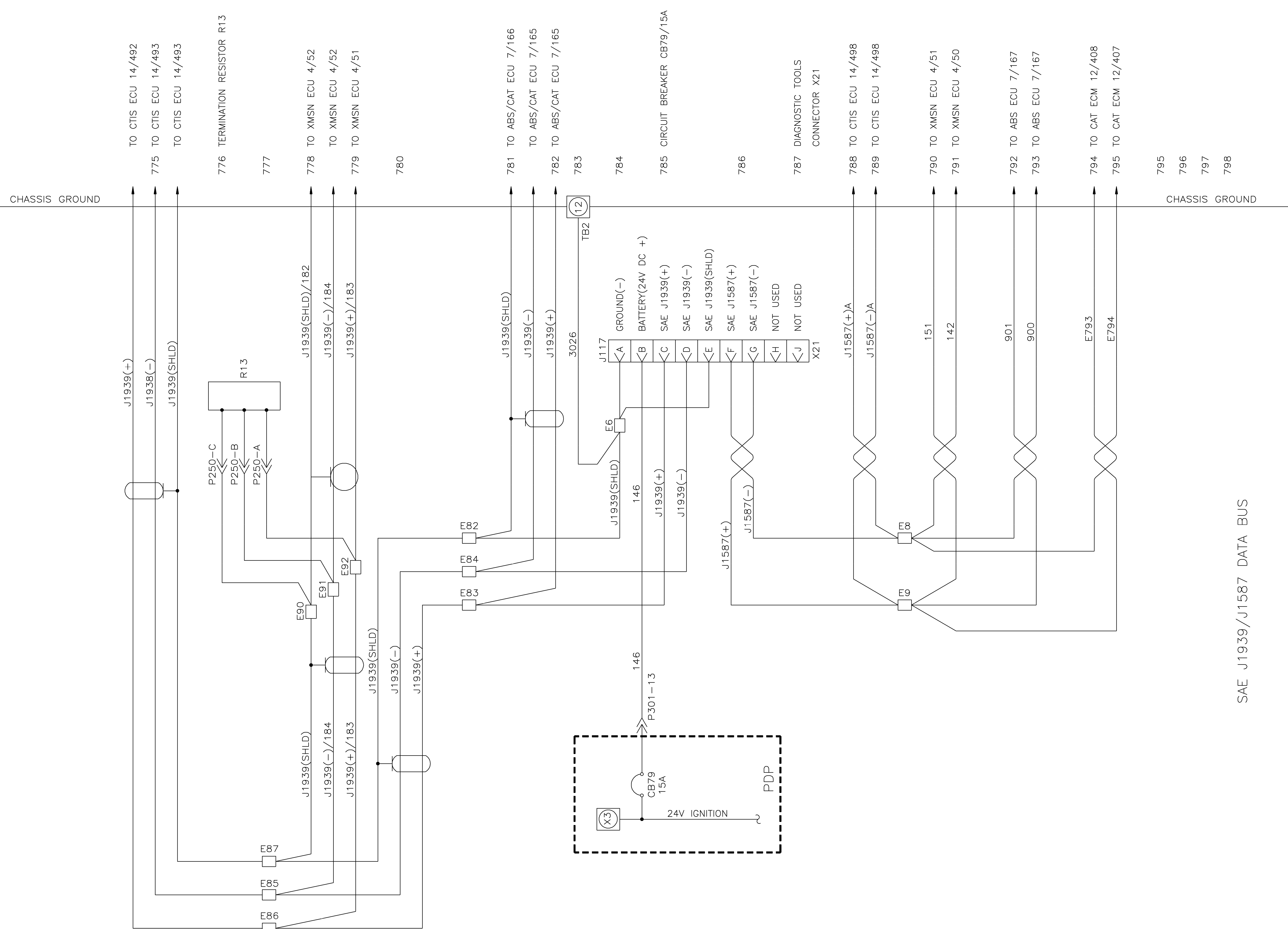

SAE J1939/J1587 DATA BUS

CM APPROVED
1-29-04
PERECP7385R1
DOCUMENT

DISTRIBUTION STATEMENT C:
 DISTRIBUTION AUTHORIZED TO U.S. GOVERNMENT AGENCIES AND THEIR CONTRACTORS.
 REASON: ADMINISTRATIVE OR OPERATIONAL USE, DATE OF DETERMINATION: 02-09-18
 OTHER REQUESTS FOR THIS DOCUMENT SHALL BE REFERRED TO THE U.S. ARMY TANK AUTOMOTIVE AND ARMAMENTS COMMAND, ATTN: SFAE-CSS-MT. WARREN, MICHIGAN 48397-5000

DESTRUCTION NOTICE: FOR UNCLASSIFIED, LIMITED DOCUMENTS DESTROY BY ANY METHOD THAT WILL PREVENT DISCLOSURE OF CONTENTS OR RECONSTRUCTION OF THE DOCUMENT.

MECHANICAL PROPERTIES	PMIC A	UNLESS OTHERWISE SPECIFIED DIMENSIONS ARE IN MILLIMETERS	CONTRACT NUMBER	DAAE07-99-C-5030	DESIGN ACTIVITY	U.S. ARMY, TANK AUTOMOTIVE COMMAND WARREN, MICHIGAN 48397-5000
	Y.P.		TOLERANCES ON	CONTRACTOR	STEWART & STEVENSON SERVICES SEALY, TEXAS U.S.A.	SCHEMATIC, ELECTRICAL
TS	1 PLACE	2 PLACE	DRAWN BY	A.JOINER	DATE (YY-MM-DD)	
EL2	±	±	CHECKER	S.E.HALL	ENGINEER	L.RODNEY
RA			THIRD ANGLE PROJECTION			
BH			DA	P.FIESTER	DRAWING APPROVAL - GOV'T	J. QUADERER
RH			MAT'L ENGR	M.CHURCH	DESIGN APPROVAL - GOV'T	J. QUADERER
	NEXT ASSY	USED ON	SCALE	E 19207	CAGE CODE	12422872
	APPLICATION		SCALE	NONE	UNIT WT	SHEET 20